



Start met bridge 2

Jacques Barendregt en Koos Vrieze

Hoofdstuk
10

- De zwakke twee en preëemptieve openingen



Overzicht openingsbod op 1 niveau

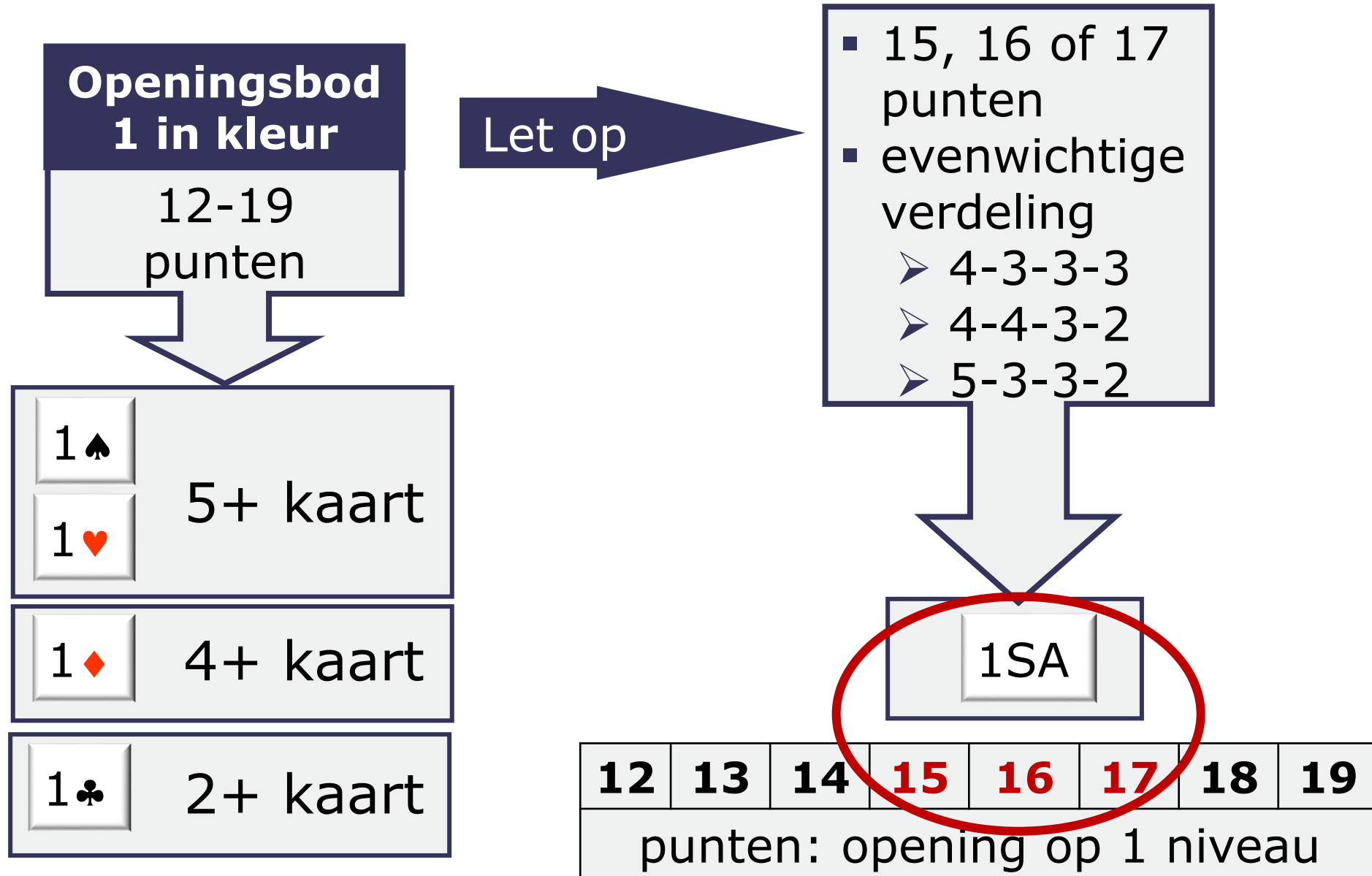

De sterkste openingen

- 20, 21 of 22 punten
- evenwichtige verdeling
 - 4-3-3-3
 - 4-4-3-2
 - 5-3-3-2

2SA

- 20+ punten
- onevenwichtig
 - één of twee kleurenspeel

2♣^A

- 23+ punten
- evenwichtige verdeling
 - 4-3-3-3
 - 4-4-3-2
 - 5-3-3-2

2♣^A

Na 2♣

- onderzoek wat voor type hand

De zwakke openingen

- 6-10 punten
- goede zeskaart

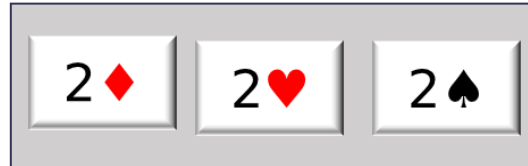

- 6-10 punten
- goede zevenkaart



- 6-10 punten
- goede achtkaart



'zwakke twee'

- 5(NK)-6(K) slagen in geboden kleur als troef

'preëemptieve openingen'

- op 3 niveau: 7(NK)-8(K) slagen in geboden kleur als troef
- op 4 niveau: 8(NK)-9(K) slagen in geboden kleur als troef

Tellen van speelslagen

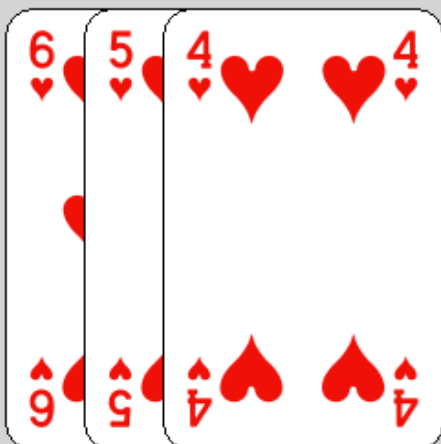

2

+

3

- 5 slagen als harten troef is

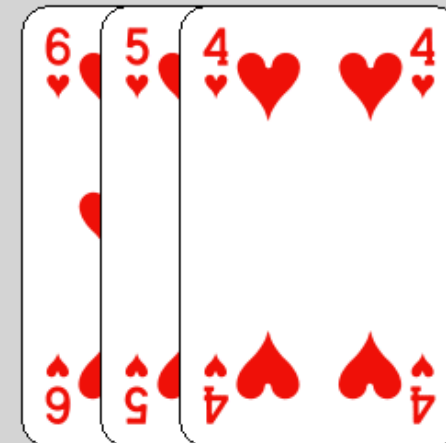
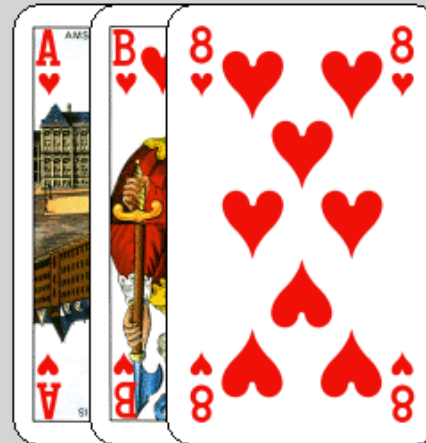

1

+

3

- 4 slagen als harten troef is

Speelslagen tellen met lange kleur

- tel hoeveel slagen je van de hoogste 3 kaarten kunt halen (indien troef):
- tel daar vervolgens de rest bij.

Openingsbod? (1)

| | | | |
|----------|----------|----------|----------|
| W | N | O | Z |
| | | Stop | 2♦ |

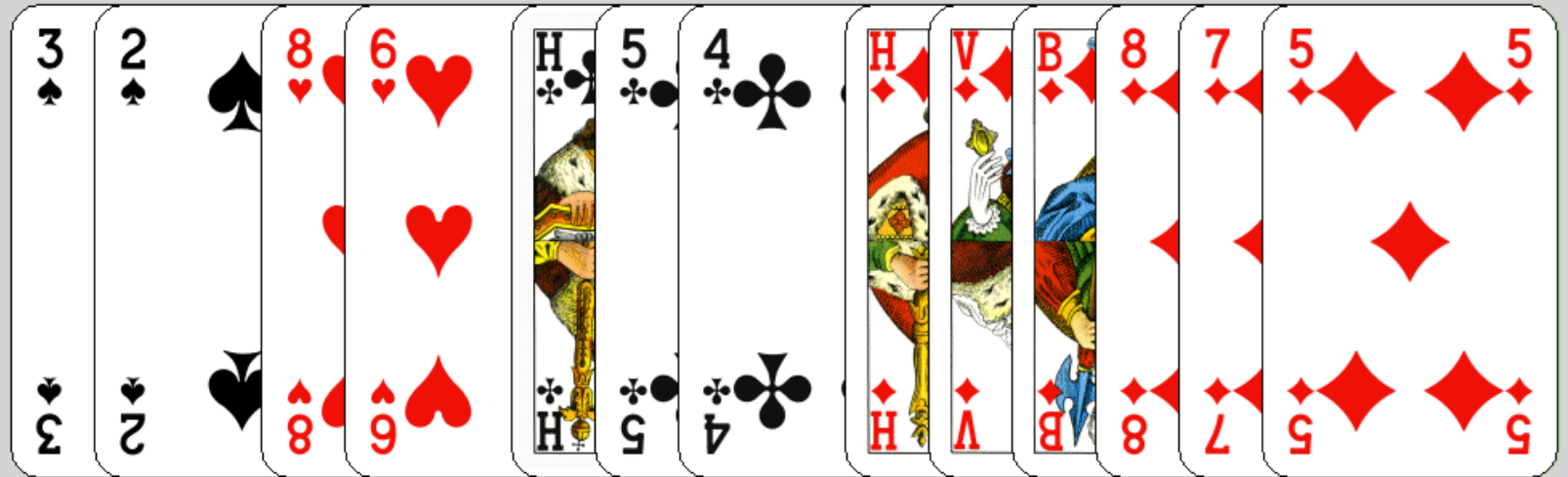

Analyse

| | |
|-------------------------|-----|
| Punten? | 9 |
| Speelslagen ♦ troef? | 5/6 |
| Bod? | 2♦ |

Je belooft

- 6-10 pnt
- 6 krt ♦
- 5 á 6 speelslagen met ruiten als troef
- geen 4 krt hoog!

Openingsbod? (2)

| W | N | O | Z |
|---|---|---|-----|
| | | | pas |

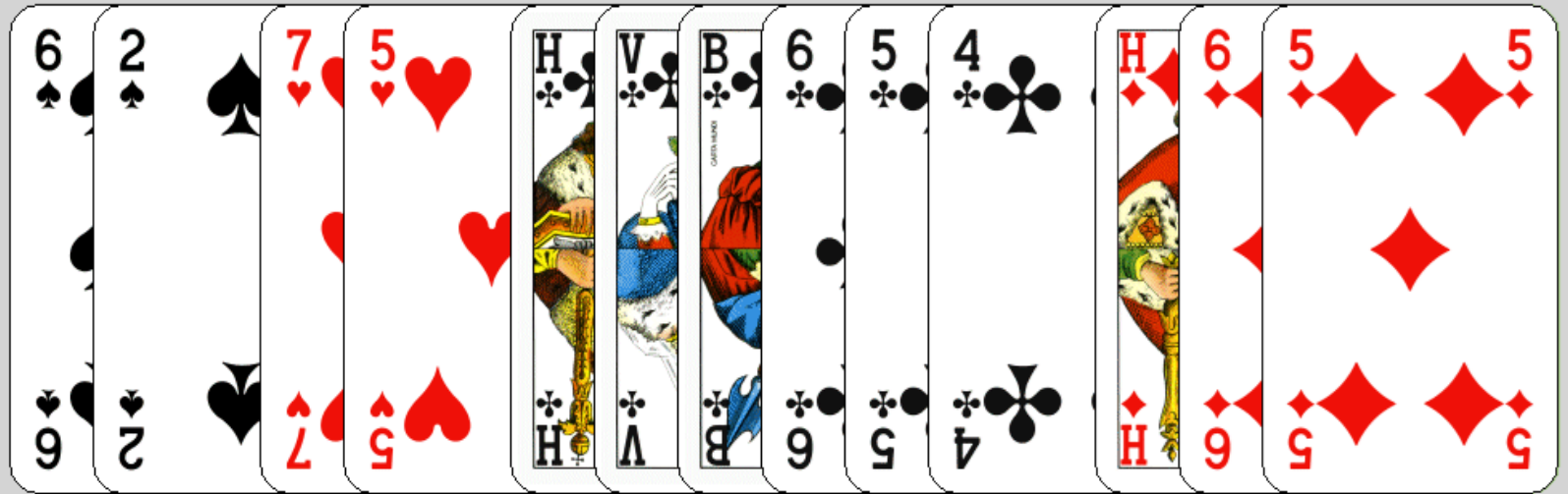

Analyse

| | |
|-------------------------|-----|
| Punten? | 9 |
| Speelslagen ♣ troef? | 5/6 |
| Bod? | pas |

Merk op

- Opening 2♣ is je sterkste opening!

Openingsbod? (3)

| | | | |
|---|---|------|----|
| W | N | O | Z |
| | | Stop | 2♥ |

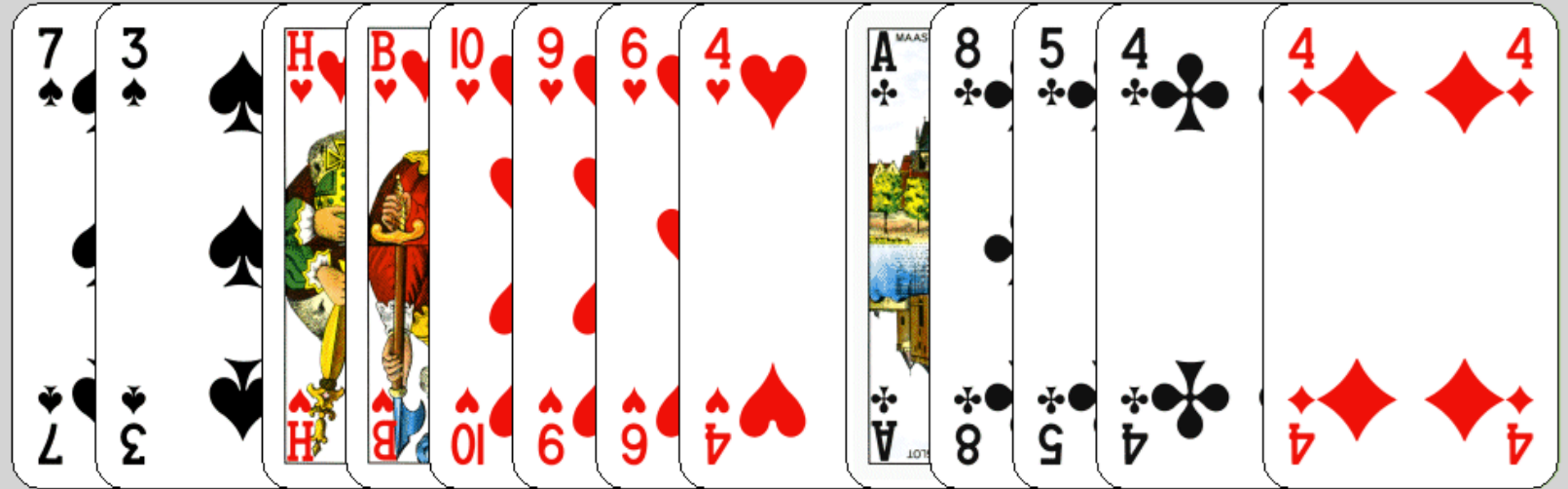

Analyse

| | |
|-------------------------|-----|
| Punten? | 8 |
| Speelslagen ♥ troef? | 5/6 |
| Bod? | 2♥ |

Je belooft

- 6-10 pnt
- goede 6 krt ♥
- geen 4 krt ♠!

Openingsbod? (4)

| | | | |
|---|---|---|-----|
| W | N | O | Z |
| | | | pas |

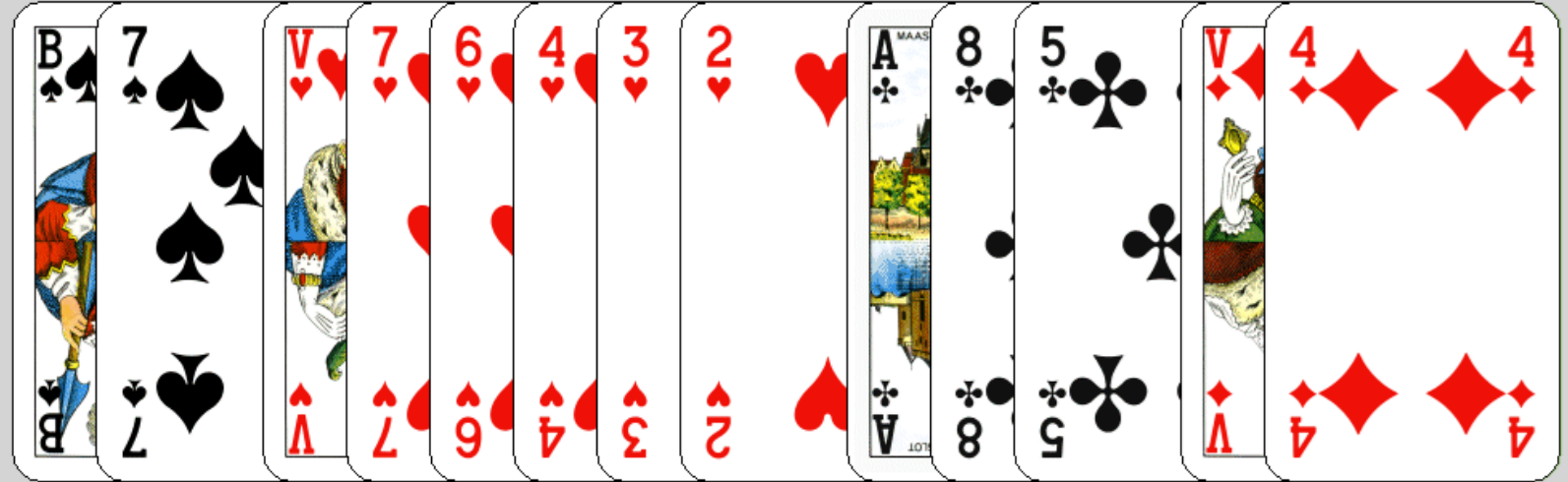

Analyse

| | |
|-------------------------|-----|
| Punten? | 9 |
| Speelslagen ♥ troef? | 4/5 |
| Bod? | pas |



'Mottige 6-kaart harten'

- Weliswaar 9 punten
- Maar 'slechte' punten
- Bij lange kleuren: slagen belangrijker dan punten

Openingsbod? (5)

| W | N | O | Z |
|---|---|---|----|
| | | | 1♥ |

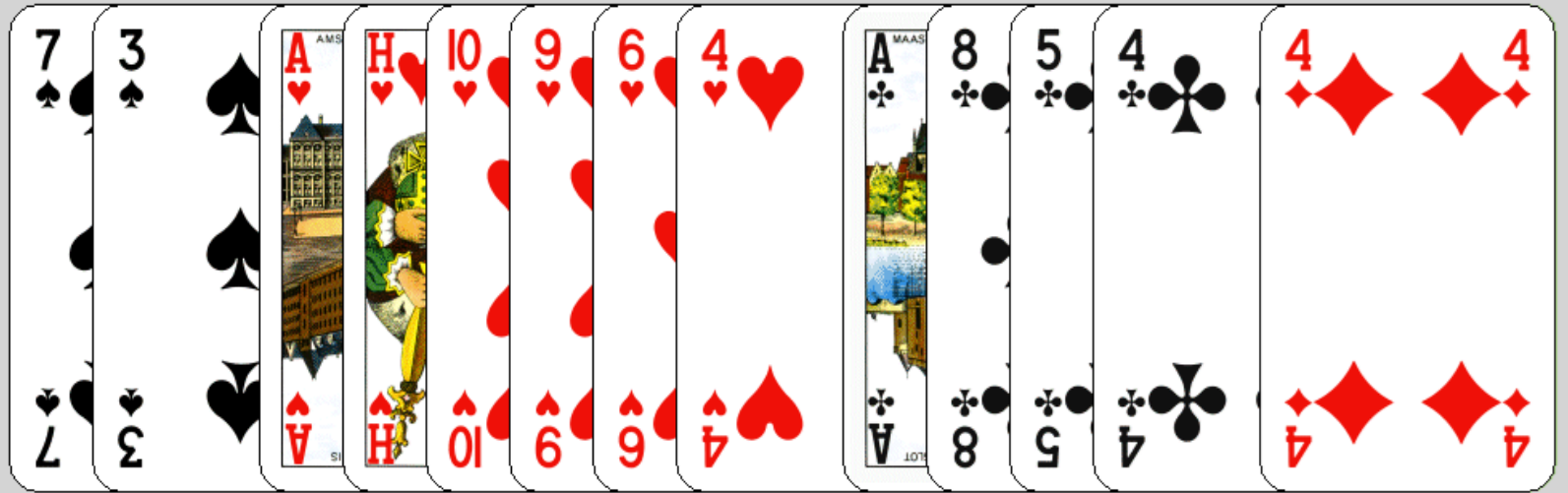

Analyse

| | |
|-------------------------|----|
| Punten? | 11 |
| Speelslagen ♥ troef? | 6 |
| Bod? | 1♥ |

Merk op

- Weliswaar 11 punten
- Maar 'goede' punten
- Soms moet je een beetje 'spelen' met de punten

Openingsbod? (6)

| W | N | O | Z |
|---|-----|-----|---|
| | pas | pas |  |

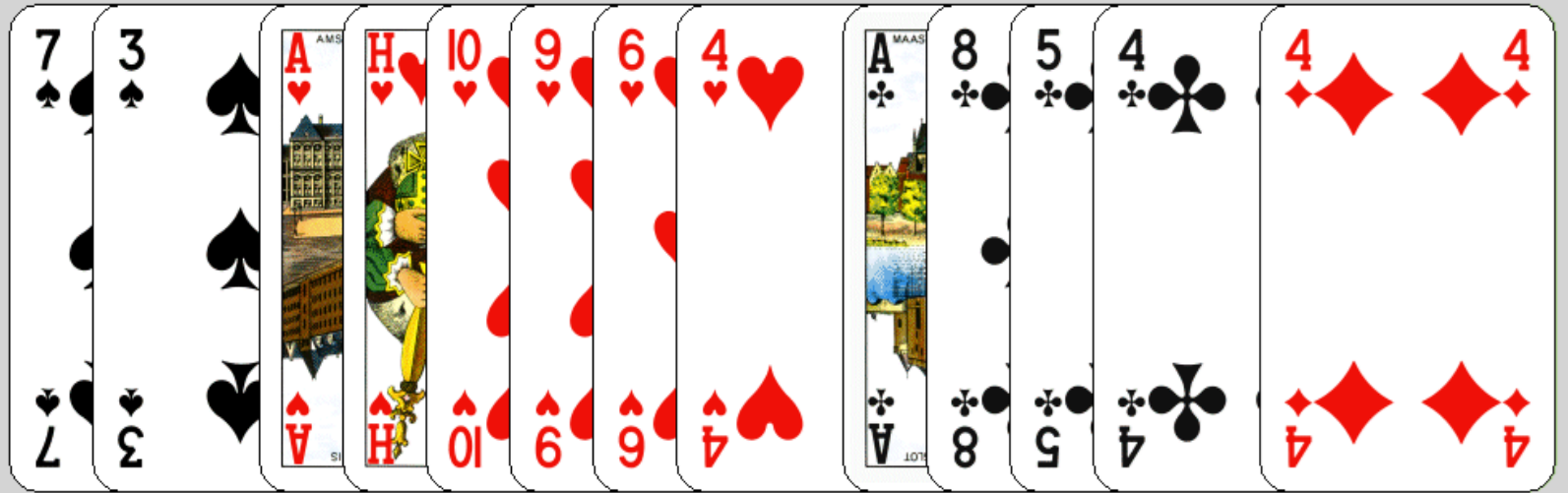

Analyse

| | |
|------------------------------------|----|
| Maximaal punten met partner samen? | 22 |
| Speelslagen ♥ troef? | 6 |
| Bod? | 2♥ |

Merk op

- Weliswaar 11 punten
- Na voorgepaste partner kans op manche klein
- Maak het bieden voor de TP lastig

Antwoord op zwakke twee (1)

| W | N | O | Z |
|---|----|-----|-----|
| | 2♦ | pas | 2SA |

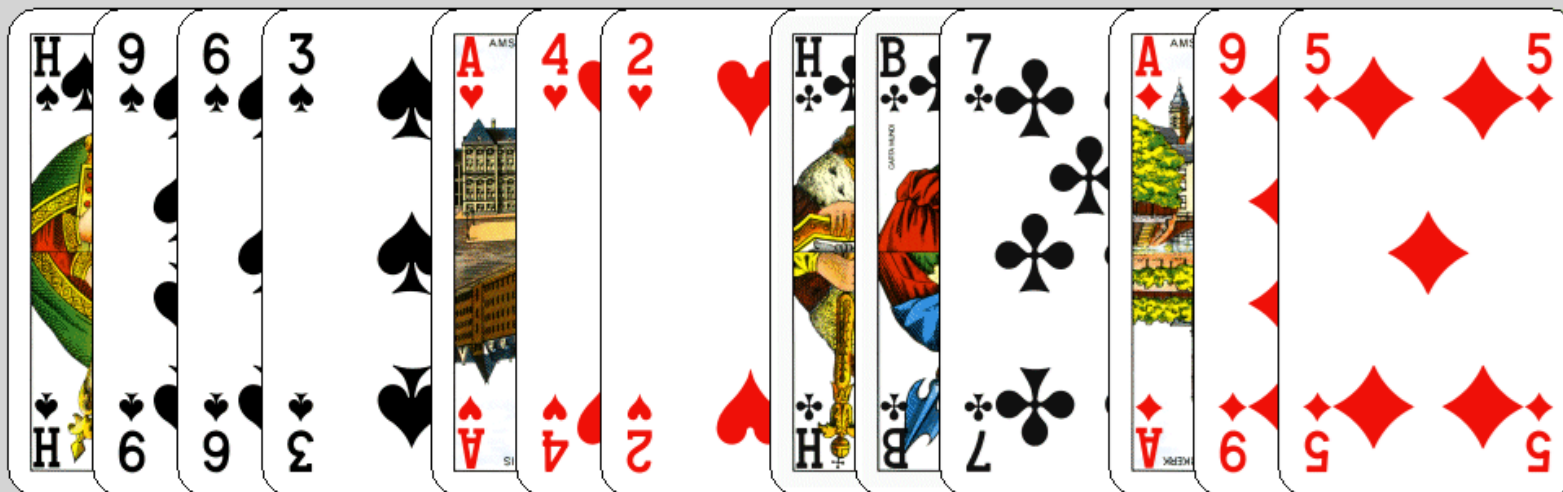

Analyse

| | |
|--------------------------------|-----|
| Speelslagen bij partner? | 5-6 |
| Speelslagen jouw hand voor SA? | 3 |
| Bod? | 2SA |

Merk op

- Tel nu niet in punten, maar in mogelijke slagen
- Als partner maximaal is, is 3SA haalbaar
- 2SA: is inviterend

Antwoord op zwakke twee (2)

| W | N | O | Z |
|---|----|-----|-----|
| | 2♦ | pas | pas |

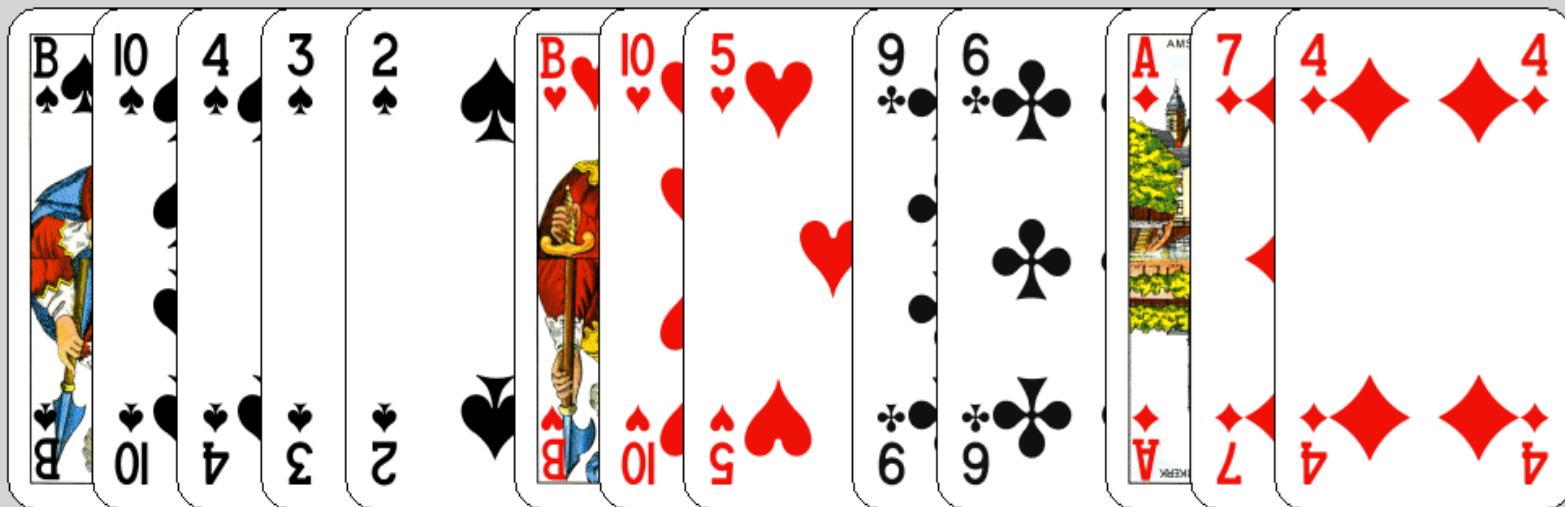

Analyse

| | |
|--------------------------|-----|
| Speelslagen bij partner? | 5-6 |
|--------------------------|-----|

| | |
|--------------------------------|-----|
| Speelslagen jouw hand voor SA? | 1-2 |
|--------------------------------|-----|

| | |
|------|-----|
| Bod? | pas |
|------|-----|

Merk op

- In een ruitencontract nog een kans op een introever in klaveren

Bijbod na zwakke '2♦'

| W | N | O | Z |
|---|----|-----|---|
| | 2♦ | pas |  |

| | |
|-----|--|
| pas | <ul style="list-style-type: none">< 3/4 speelslagen meegeen zicht op 3SA |
| 2SA | <ul style="list-style-type: none">zeker 3 speelslagen mee♦-fit; alle kleuren dekkinginviterend |
| 3SA | <ul style="list-style-type: none">zeker 4 speelslagen mee♦-fitalle kleuren dekking |

Let op

- in een SA contract belangrijk dat je ruiten mee hebt om bij partner te komen

Let op

- ga niet op avontuur in een andere kleur, tenzij je zeker weet dat dat beter is

Bijbod na zwakke '2♥'

| W | N | O | Z | |
|---|----|-----|---|--|
| | 2♥ | pas |  | |

| | |
|-----|--|
| 3♥ | <ul style="list-style-type: none">♥-fit;2/4 slagen meeinviterend |
| 4♥ | <ul style="list-style-type: none">♥-fit;4/5 slagen mee |
| pas | <ul style="list-style-type: none">< 3 slagen mee |

The diagram illustrates a bridge bidding sequence. On the left, a table shows the bidding process: West (W) is blank, North (N) bids 2♥, East (O) passes (pas), and South (Z) makes a red heart icon. Three arrows point from the South position to a larger table on the right, which details the possible responses from North:

- 3♥:** ♥-fit; 2/4 slagen mee; inviterend
- 4♥:** ♥-fit; 4/5 slagen mee
- pas:** < 3 slagen mee

Bijbod na zwakke '2♠'

| W | N | O | Z |
|---|----|-----|---|
| | 2♠ | pas |  |

| | |
|-----|--|
| 3♠ | <ul style="list-style-type: none">♠-fit;2/4 slagen meeinviterend |
| 4♠ | <ul style="list-style-type: none">♠-fit;4/5 slagen mee |
| pas | <ul style="list-style-type: none">< 3 slagen mee |

The diagram illustrates a bridge bidding sequence. On the left, a table shows the bidding process: West (W) is blank, North (N) bids 2♠, East (O) passes, and South (Z) is shown with a red telephone receiver icon, indicating a weak hand. Three arrows point from the South position to a larger table on the right, which details the possible responses from North:

- 3♠:** ♠-fit; 2/4 slagen mee; inviterend.
- 4♠:** ♠-fit; 4/5 slagen mee.
- pas:** < 3 slagen mee.

Antwoord op zwakke twee (3)

| W | N | O | Z |
|---|----|-----|-----|
| | 2♠ | pas | pas |

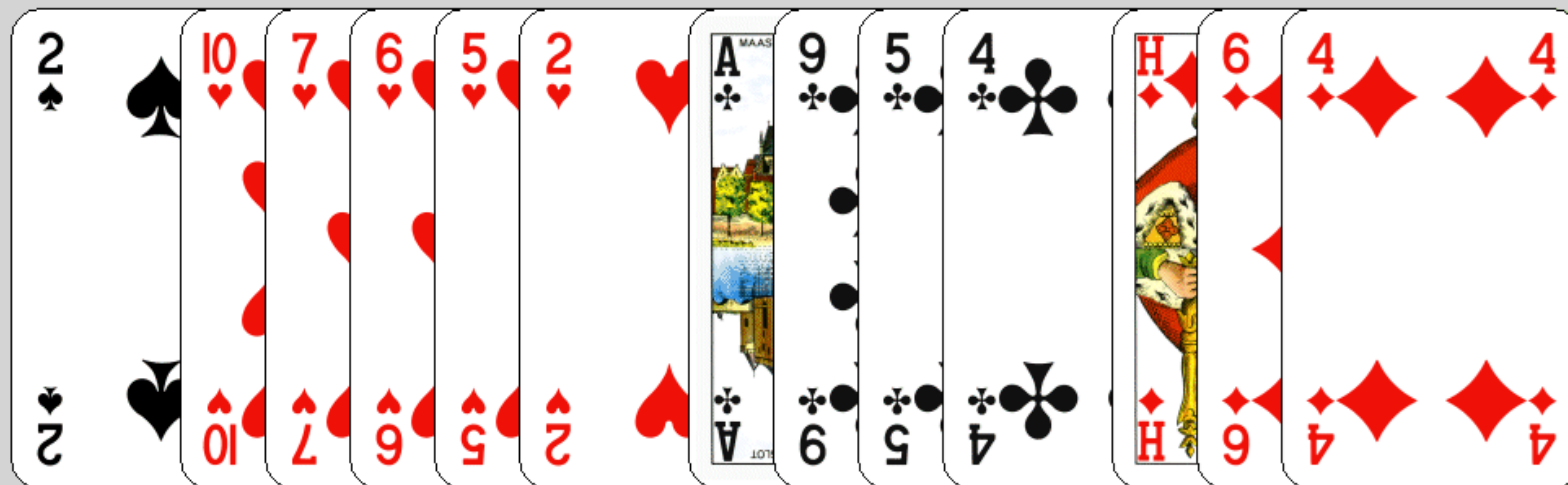

Analyse

| | |
|--------------------------|-----|
| Speelslagen bij partner? | 5-6 |
|--------------------------|-----|

| | |
|-----------------------------|-----|
| Speelslagen jouw hand in ♠? | 1-2 |
|-----------------------------|-----|

| | |
|------|-----|
| Bod? | pas |
|------|-----|

Merk op

- Ga niet op zoek naar een betere fit

Antwoord op zwakke twee (4)

| W | N | O | Z |
|---|----|-------------|----|
| | 2♠ | Stop pas | 4♠ |

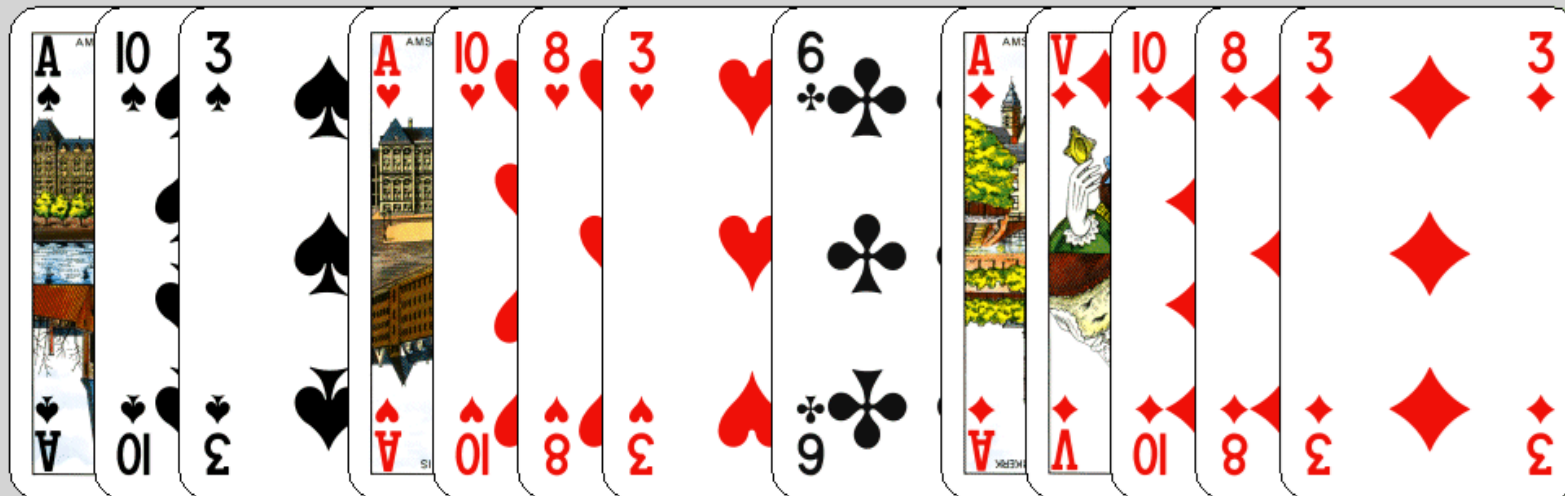

Analyse

| | |
|--------------------------|-----|
| Speelslagen bij partner? | 5-6 |
|--------------------------|-----|

| | |
|-----------------------------|-----|
| Speelslagen jouw hand in ♠? | 4/5 |
|-----------------------------|-----|

| | |
|------|----|
| Bod? | 4♠ |
|------|----|

Merk op

- 4♠ is zeer kansrijk
- kans op 1 á 2 introevers in klaveren
- kans op slagen in ruiten

Antwoord op zwakke twee (5)

| W | N | O | Z |
|---|----|-----|----|
| | 2♠ | pas | 3♠ |

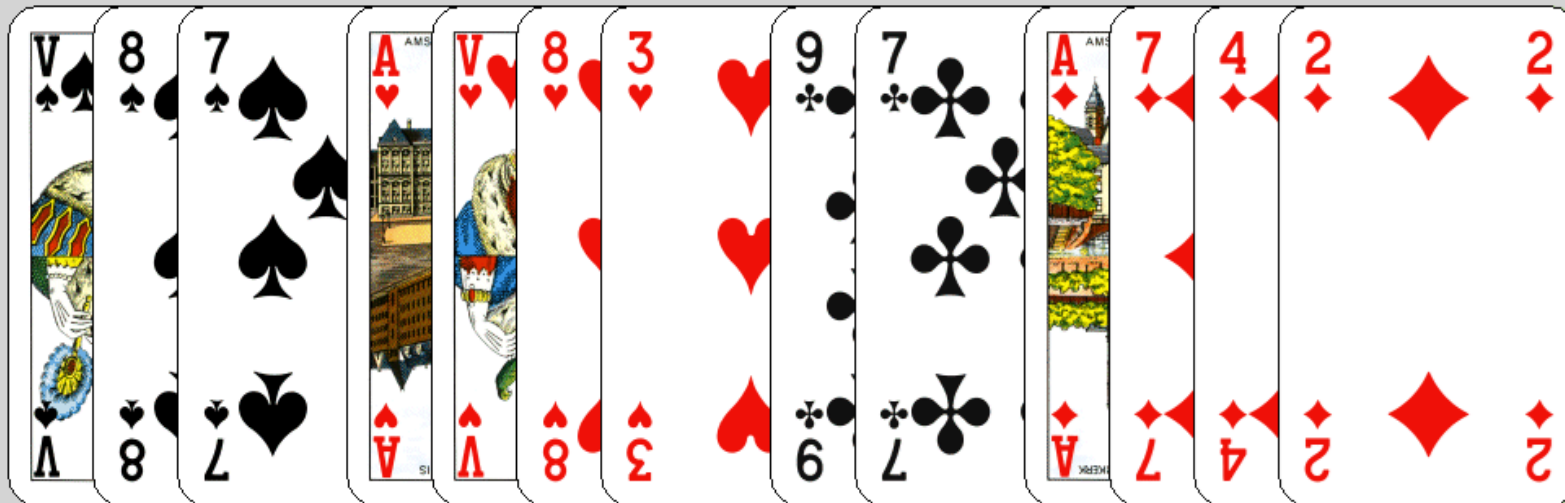

Analyse

| | |
|--------------------------|-----|
| Speelslagen bij partner? | 5-6 |
|--------------------------|-----|

| | |
|-----------------------------|-----|
| Speelslagen jouw hand in ♠? | 3/4 |
|-----------------------------|-----|

| | |
|------|----|
| Bod? | 3♠ |
|------|----|

Inviterend

- Met 3♠ vraag je om 4♠ te bieden als partner met een maximale 2♠ heeft geopend

Preëemptief bieden: doel (1a)

| W | N | O | Z |
|---|---|-----|-----|
| | | pas | 1SA |

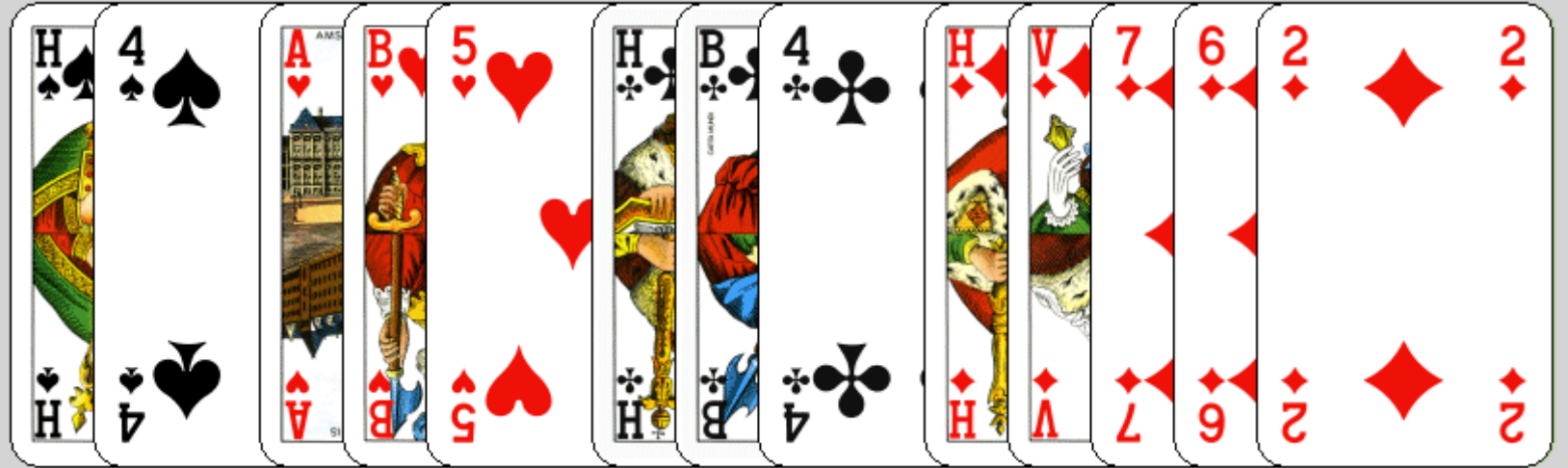

- Wat bied je?
 - 1SA
 - evenwichtig; 15-17 pnt

Preëemptief bieden: doel (1b)

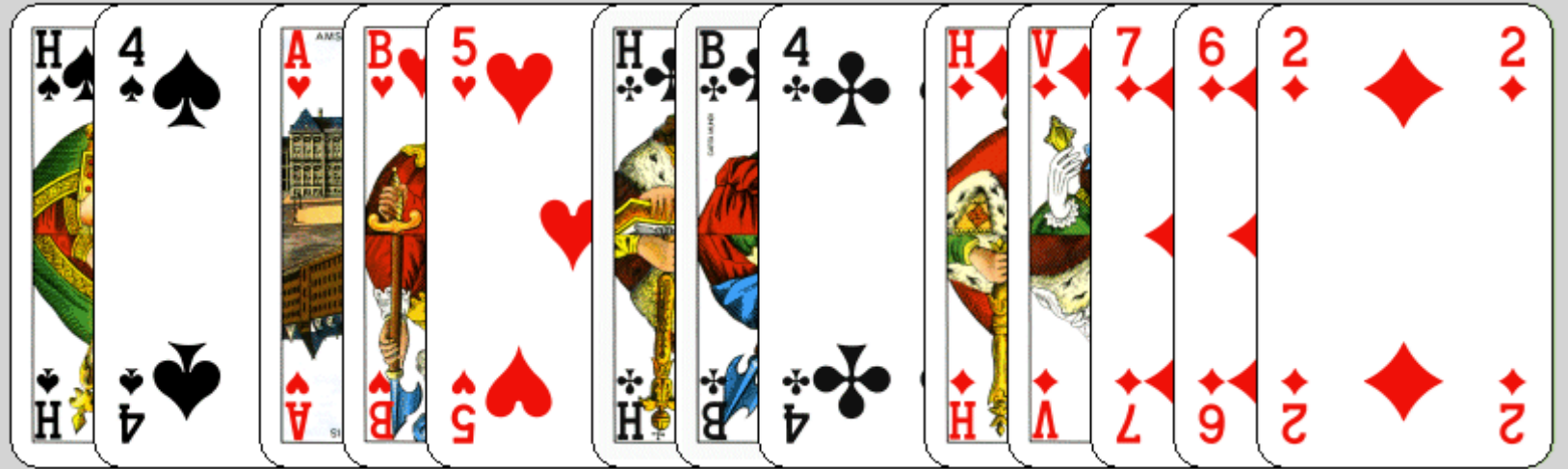
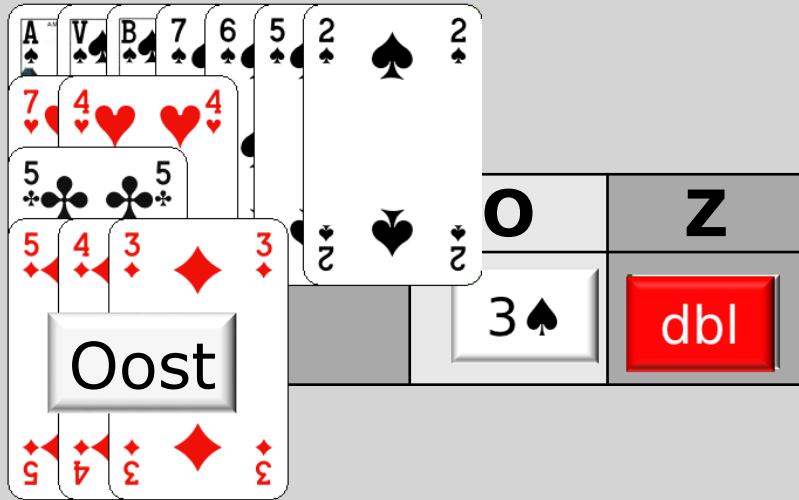

■ Maar oost 3♠; wat bied je nu?

- pas
 - te voorzichtig?
- 3SA
 - 😊 of ☹
- doublet
 - 😊 of ☹

Doel preëemptief openen:

- Tegenpartij dwars zitten
- hun bieden wordt 'gokwerk'

Preëemptieve openingen



- goede 7 kaart (2 honneurs)
- tot 10 pnt



- goede 8 kaart (2 honneurs)
- tot 10 pnt

Bied op basis van slagen

- Met jouw lange kleur als troef kun je 2 á 3 slagen minder maken dan je belooft

Openingsbod? (7)

| | | | |
|----------|----------|----------|----------|
| W | N | O | Z |
| | | Stop | 3♥ |

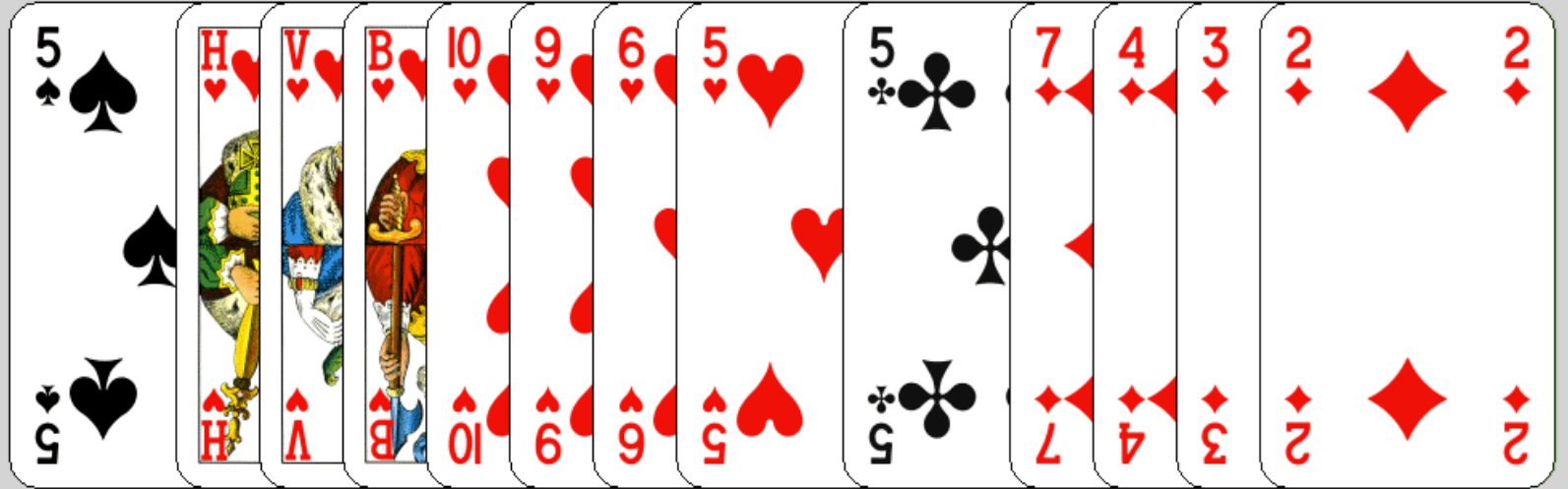

Analyse

| | |
|--------------------------------|----|
| Punten? | 6 |
| Speelslagen jouw hand in ♥? | 6 |
| Bod? | 3♥ |

Inviterend

- 7 krt ♥
- 6-10 pnt
- 6-7 slagen met harten als troef

Openingsbod? (8)

| | | | |
|---|---|------|----|
| W | N | O | Z |
| | | Stop | 4♥ |

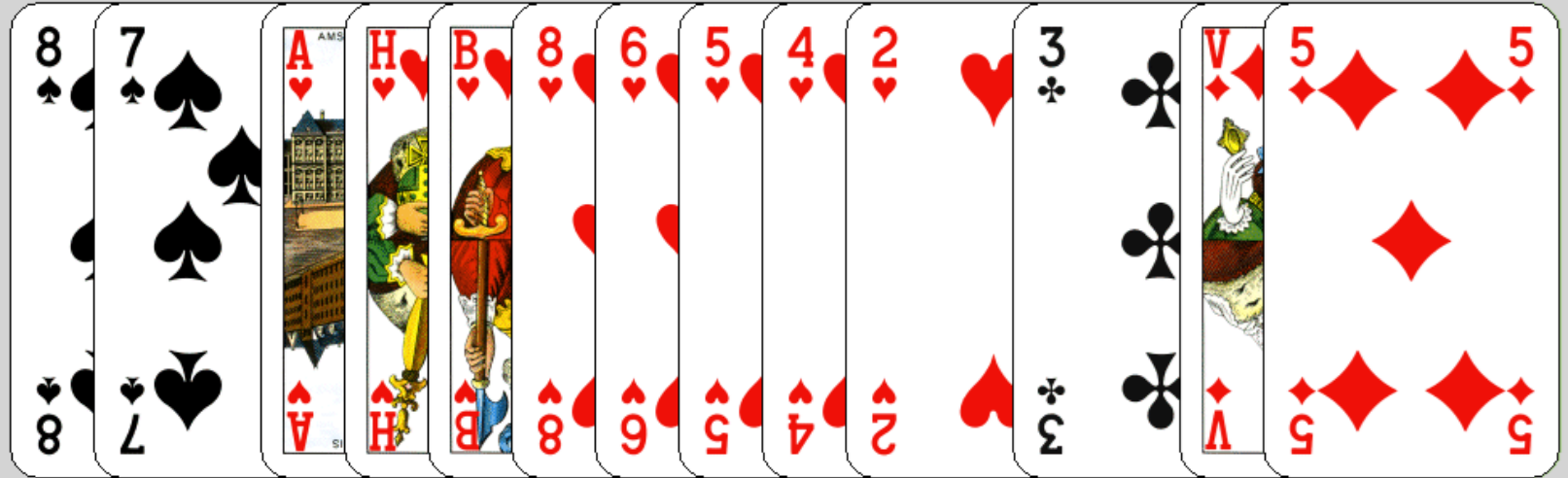

Analyse

| | |
|--------------------------------|-----|
| Punten? | 10 |
| Speelslagen jouw hand in ♥? | 7-8 |
| Bod? | 4♥ |

Je belooft

- 8 krt ♥
- 6-10 pnt
- 7-8 slagen met harten als troef

Verder na preëmtieve opening van partner (1)

| W | N | O | Z |
|---|----|-----|----|
| | 3♠ | pas | 4♠ |

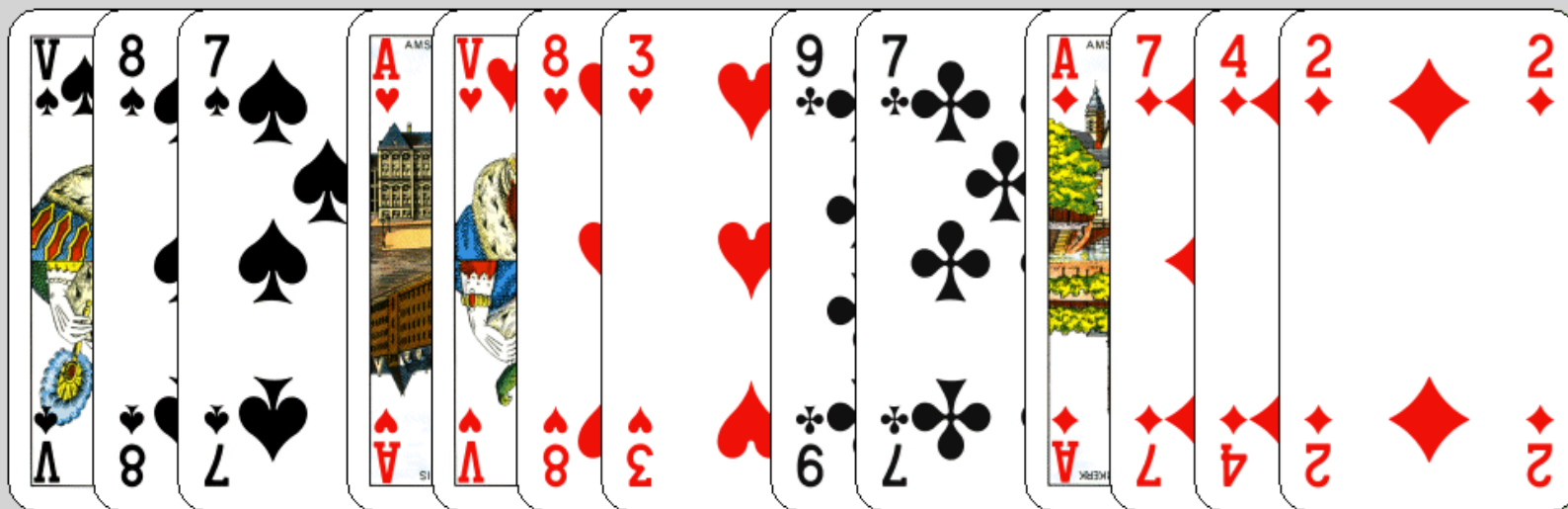

Analyse

| | |
|-------------------------------|-----|
| Speelslagen in ♠ bij partner? | 6-7 |
| Hoeveel slagen breng jij mee? | 3-4 |
| Bod? | 4♠ |

Je belooft

- > 3 speelslagen mee

Verder na preëmtieve opening van partner (2)

| W | N | O | Z |
|---|----|-----|-----|
| | 3♥ | pas | pas |

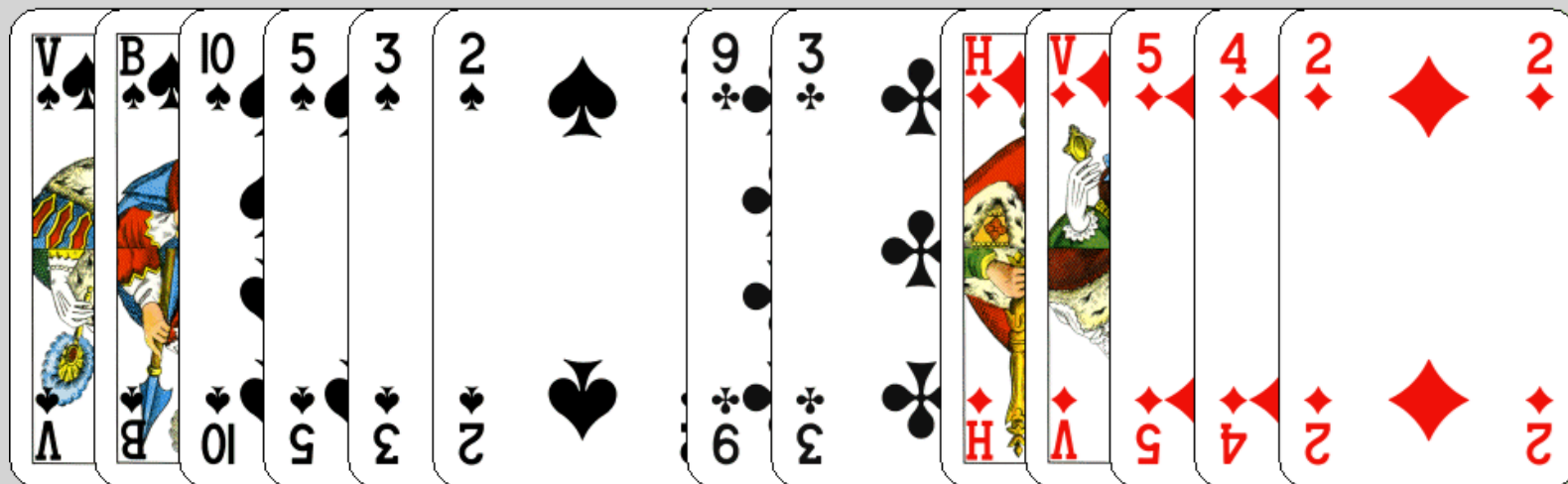

Analyse

| | |
|-------------------------------|-----|
| Speelslagen in ♥ bij partner? | 6-7 |
| Hoeveel slagen breng jij mee? | 2 |
| Bod? | pas |

Tip

- ga niet weglopen
- geen garantie dat ♠ of ♦ beter is

Verder na preëmtieve opening van partner (3)

| W | N | O | Z |
|---|----|-----|-----|
| | 3♦ | pas | 3SA |

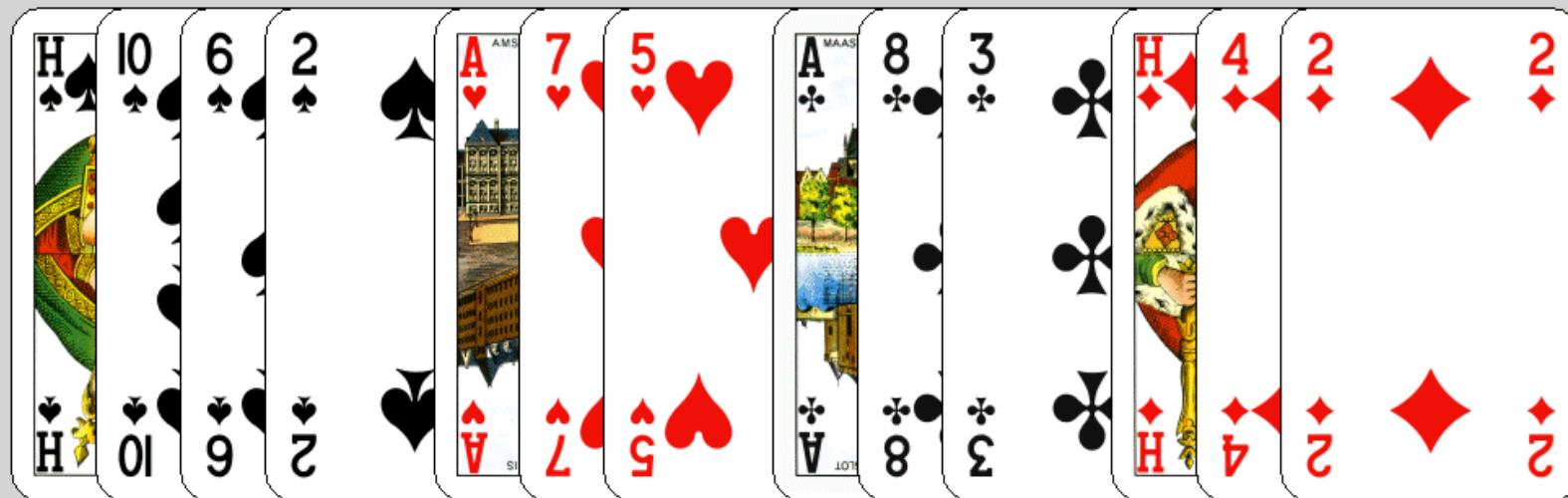

Analyse

| | |
|-------------------------------|-----|
| Speelslagen in ♦ bij partner? | 6-7 |
| Hoeveel slagen breng jij mee? | 3-4 |
| Bod? | 3SA |

Merk op

- grote kans op 9 slagen in SA
- partner brengt 6-7 ruitenslagen mee

Bijbod na preëemptieve opening (3)

**antwoord
na 3♣ / ♦**

- meestal pas
- 3SA (sterk):
 - overal dekking
 - 3 krt steun
 - 3 speelslagen mee

**antwoord
na 3♥ / ♠**

- pas
- of steunen (manche kansen)
 - 3 speelslagen mee

Preëemptief en kwetsbaarheid

| W | N | O | Z |
|-----|-----|-----|-----|
| | | 3♠ | dbl |
| pas | pas | pas | |

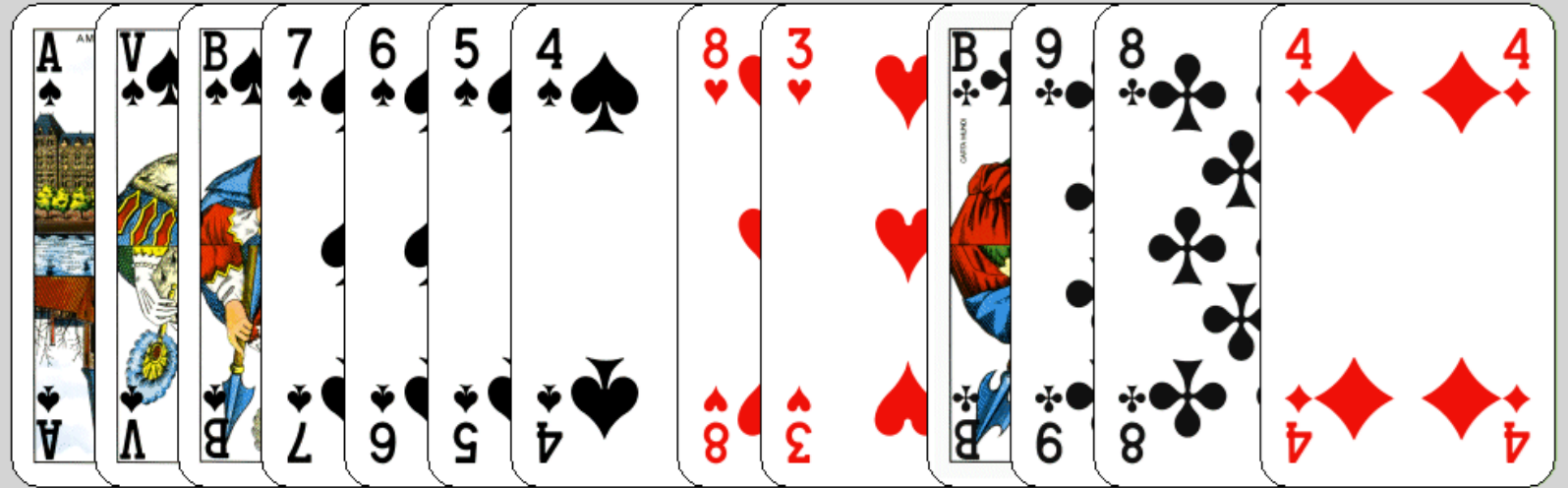

- Jij opent deze hand met 3♠
- De ene TP partij biedt 4♥
- De andere TP doubleert 3♠

Niemand Kwetsbaar

| Contract | Jouw score |
|----------------------|-------------|
| ■ TP: 4♥ C | -420 |
| ■ Jij: 3♠x -2 | -300 |
| Winst bij dbl | +120 |

Preëemptief en kwetsbaarheid

| W | N | O | Z |
|-----|-----|-----|-----|
| | | 3♠ | dbl |
| pas | pas | pas | |

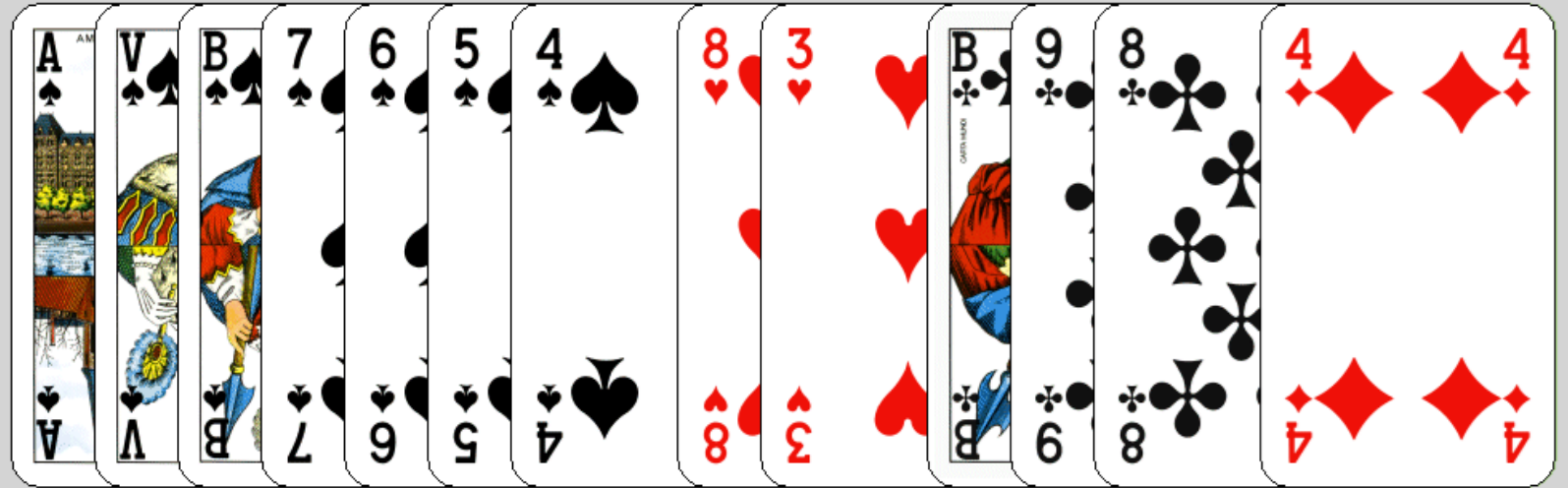

- Jij opent deze hand met 3♠
- De ene TP partij biedt 4♥
- De andere TP doubleert 3♠

Jouw partij Kwetsbaar

| Contract | Jouw score |
|------------------------|------------|
| ▪ TP: 4♥ C | -420 |
| ▪ Jij: 3♠x -2 | -500 |
| verlies bij dbl | -80 |

Zelf kwetsbaar tegen niet kwetsbaar risico groter om preëemptief te openen

Biedoefening West-Oost (1)

W / -

Hand 1: 6♥, 5♥, 5♥, 2♣, 2♣, 2♣, 2♣, 2♣, 2♣, 2♣, 2♣, 2♣

Hand 2: A♥, V♥, 10♥, 8♥, 3♥, 2♥, 2♥, 2♥, 2♥, 2♥, 2♥, 2♥

Hand 3: A♠, 8♠, 7♠, 7♠, 3♥, 2♥, 2♥, 2♥, 2♥, 2♥, 2♥, 2♥

Hand 4: A♣, 10♣, 9♣, 8♣, 8♣, 8♣, 8♣, 8♣, 8♣, 8♣, 8♣, 8♣

Hand 5: A♥, 9♥, 4♦, 4♦, 4♦, 4♦, 4♦, 4♦, 4♦, 4♦, 4♦, 4♦

10 pnt
6-5-2

14 pnt
4-3-3-3

| West | N | Oost | Z |
|------|-----|------|-----|
| 2♦ | pas | 2SA | pas |
| 3SA | pas | pas | pas |

| | |
|-----|---|
| 2♦ | <ul style="list-style-type: none"> 6 krt ♦ 6-10 pnt |
| 3SA | <ul style="list-style-type: none"> maximaal |
| | |
| | |

| | |
|-----|---|
| 2SA | <ul style="list-style-type: none"> inviterend voor 3SA |
| | |
| | |
| | |

Biedoefening West-Oost (2)

W /

8 pnt
8-2-2-1

| West | N | Oost | Z |
|------|-----|------|-----|
| 4♠ | pas | pas | dbl |
| pas | pas | pas | |
| | | | |

6 pnt
5-4-3-1

| | |
|-----|---|
| 4♠ | <ul style="list-style-type: none"> 8 krt ♠ 6-10 pnt |
| pas | <ul style="list-style-type: none"> niets meer te melden |
| | |
| | |

Zuid

- Strafdoublet

| | |
|-----|--|
| pas | <ul style="list-style-type: none"> niets te melden |
| pas | <ul style="list-style-type: none"> niets meer te melden |
| | |
| | |

Bied oefening West-Oost (3)

W /

8 pnt
7-3-2-1

| West | N | Oost | Z |
|------|-----|------|-----|
| 3♦ | pas | pas | pas |
| | | | |
| | | | |

Stop

11 pnt
6-4-2-1

| | |
|----|---|
| 3♦ | <ul style="list-style-type: none"> 7 krt ♦ 6-10 pnt |
| | |
| | |
| | |

| | |
|-----|---|
| pas | <ul style="list-style-type: none"> niets te melden |
| | |
| | |
| | |

Biedoefening West-Oost (4)

O / -



| West | N | Oost | Z |
|-------------|-----|------------|-----|
| | | Stop 2♦ | pas |
| Stop 3SA | pas | pas | pas |
| | | | |

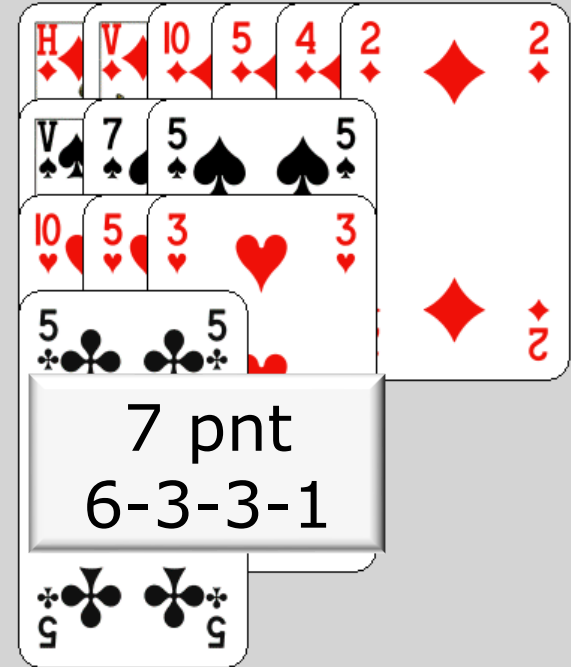

| | |
|-----|-----------------|
| | |
| 3SA | ▪ zeer kansrijk |
| | |
| | |

| | |
|-----|-------------------------|
| 2♦ | ▪ 6 krt ♦ ▪ 6-10 pnt |
| pas | ▪ niets meer te melden |
| | |
| | |

Biedoefening West-Oost (5)

O / -

Hand of West:

- ♥: A, B, 6, 6
- ♠: A, 10, 6, 3, 3
- ♦: A, V, 6, 4, 4
- ♣: 4, 4, 4, 4

18 pnt
4-4-3-2

| West | N | Oost | Z |
|------------|-----|------------|-----|
| | | Stop 2♥ | pas |
| Stop 4♥ | pas | pas | pas |
| | | | |

Hand of East:

- ♥: H, V, 10, 5, 4, 2, 2
- ♠: V, 7, 5, 5
- ♦: 10, 5, 3, 3
- ♣: 5, 5

7 pnt
6-3-3-1

| | |
|----|-----------------|
| | |
| 4♥ | ▪ zeer kansrijk |
| | |
| | |

| | |
|-----|-------------------------|
| 2♥ | ▪ 6 krt ♥ ▪ 6-10 pnt |
| pas | ▪ niets meer te melden |
| | |
| | |

Biedoefening West-Oost (6)

0 / -

Hand of West:

- Hearts: B, 4, 2, 2
- Clubs: A, H, 7, 6, 5, 3, 3
- Diamonds: H, 8, 7, 6, 6

11 pnt
6-4-3

| West | N | Oost | Z |
|------|-----|------------|-----|
| | | Stop 3♠ | pas |
| pas | pas | | |
| | | | |

Hand of East:

- Spades: A, V, B, 8, 4, 3, 2, 2
- Hearts: 8, 6, 6, 6
- Clubs: 4, 4, 4
- Diamonds: V, 5, 4, 4
- Trumps: 2, 2

7 pnt
7-3-2-1

| | |
|-----|--|
| | |
| pas | <ul style="list-style-type: none"> niets meer te melden |
| | |
| | |

| | |
|----|---|
| 3♠ | <ul style="list-style-type: none"> 7 krt ♠ 6-10 pnt |
| | |
| | |
| | |

Biedoefening West-Oost (7)

O / -

18 pnt
4-4-3-2

| West | N | Oost | Z |
|------|-----|------------|-----|
| | | Stop 3♠ | pas |
| 4♠ | pas | pas | pas |
| | | | |

9 pnt
7-3-2-1

| | |
|----|--|
| | |
| 4♠ | <ul style="list-style-type: none"> ♠-fit samen 25+ fitpunten |
| | |
| | |

| | |
|----|---|
| 3♠ | <ul style="list-style-type: none"> 7 krt ♠ 6-10 pnt |
| | |
| | |
| | |

3 opties

1. Je biedt een kleur
 - goede 5+ kaart
 - 12-16 punten
2. Je biedt SA: evenwichtig met een goede dekking in kleur tegenpartij
 - 2SA: 15-18 pnt
 - 3SA: 19+ pnt
3. Doublet
 - 12-16 pnt: alle overige kleuren OK
 - 17+ pnt met goede eigen kleur
 - deze kleur bied je later

Verdediging tegen zwakke 2 (1)

| W | N | O | Z |
|---|---|----|----|
| | | 2♥ | 2♠ |

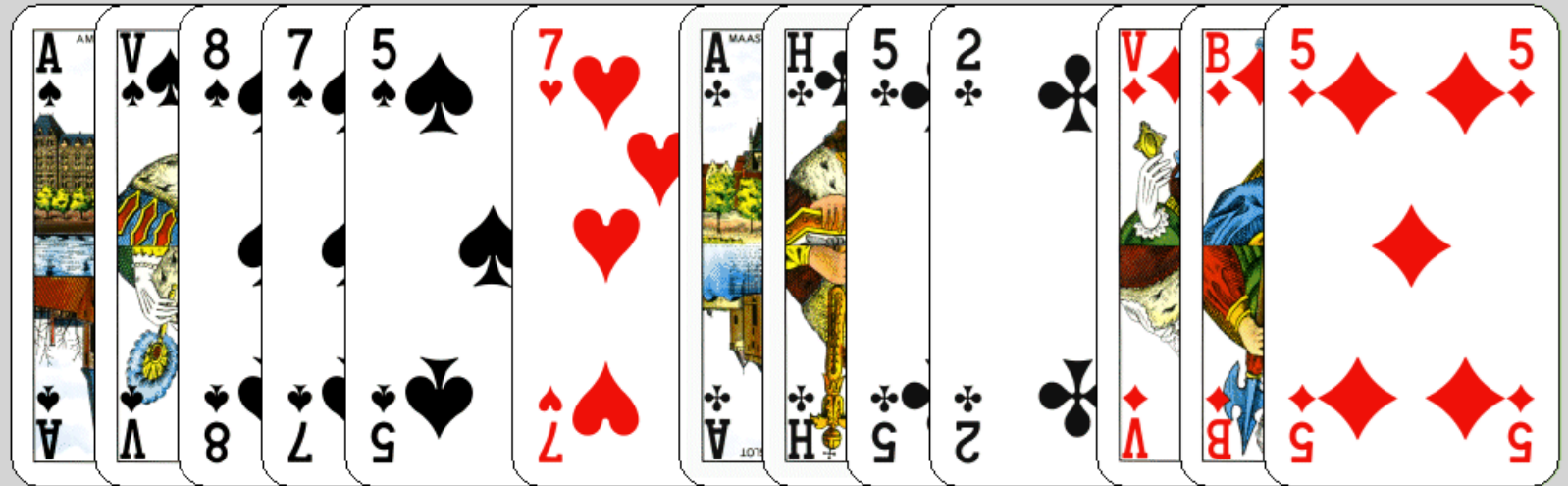

Analyse

| | |
|------------|----------|
| Punten? | 16 |
| Verdeling? | 5♠-4-3-1 |
| Bod? | 2♠ |

Je belooft

- goede 5+ krt ♠
- 10-16 pnt

Verdediging tegen zwakke 2 (2)

| W | N | O | Z |
|---|---|----|-----|
| | | 2♥ | 2SA |



Analyse

| | |
|------------|----------|
| Punten? | 16 |
| Verdeling? | 5♣-3-3-2 |
| Bod? | 2SA |

Je belooft

- 15-18 pnt
- evenwichtig
- stop in ♥

Verdediging tegen zwakke 2 (3)

| | | | |
|----------|----------|----------|----------|
| W | N | O | Z |
| | | 2♥ | dbl |

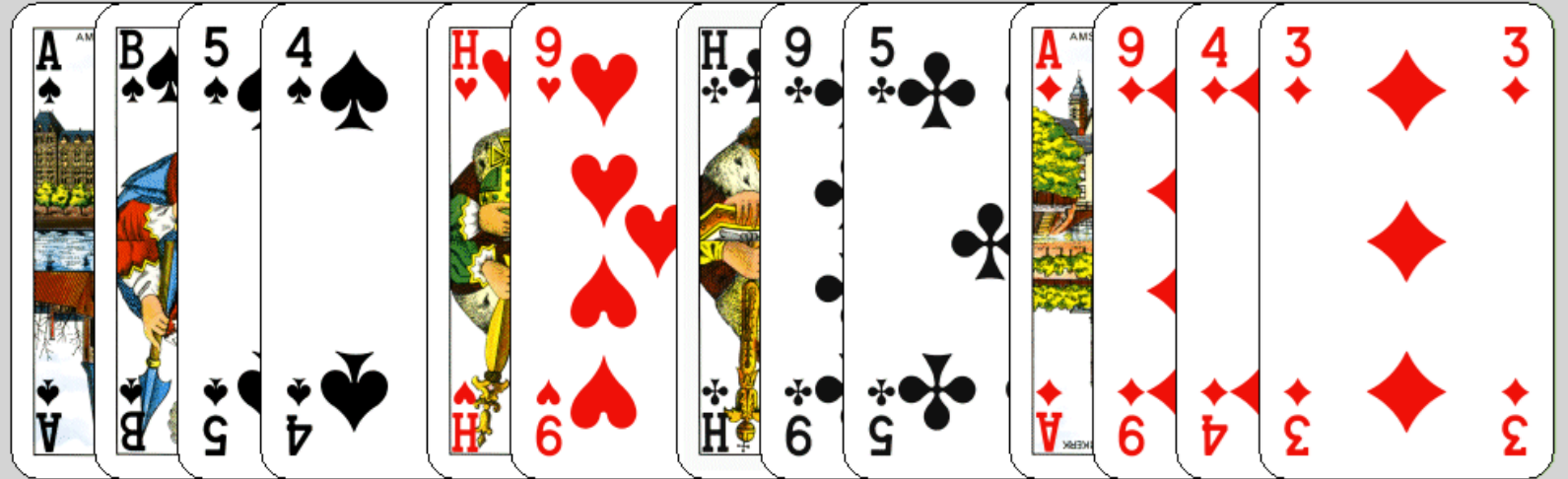

Analyse

| | |
|------------|----------|
| Punten? | 15 |
| Verdeling? | 4-4-3-2♥ |
| Bod? | doublet |

Je belooft

- 12+ pnt
- alle kleuren OK
- kort in ♥

Verdediging tegen zwakke 2 (4)

| W | N | O | Z |
|---|---|----|-----|
| | | 2♦ | pas |

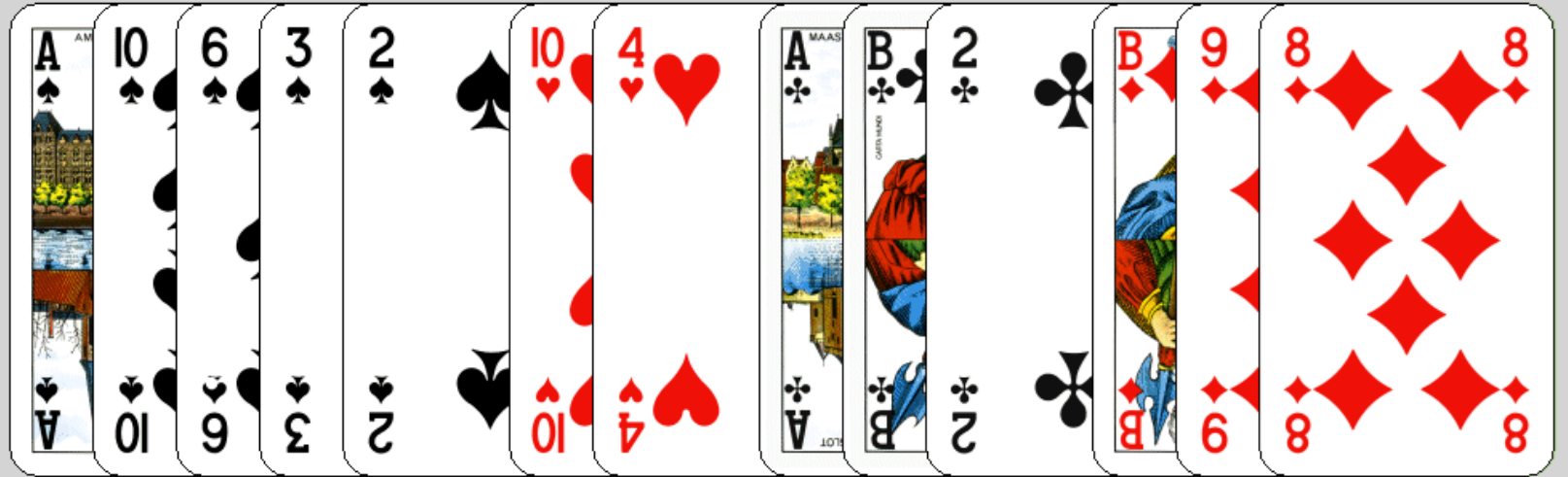

Analyse

| | |
|------------|----------|
| Punten? | 10 |
| Verdeling? | 5♠-3-3-2 |
| Bod? | pas |

Niets te melden

- te weinig speelslagen met ♠ als troef

3 opties

1. Kleur op 3 niveau:
 - goede 5+ kaart
 - 15-18 punten
2. Je biedt 3SA: evenwichtig
 - 19+ pnt
 - alle kleuren een dekking
 - goede dekking kleur TP
3. Doublet
 - 15+ pnt: alle overige kleuren OK
 - 19+ pnt met goede eigen kleur (5+ krt)
 - deze kleur bied je later

Verdediging tegen een preëemptieve opening (1)

| W | N | O | Z |
|---|---|----|----|
| | | 3♣ | 3♠ |

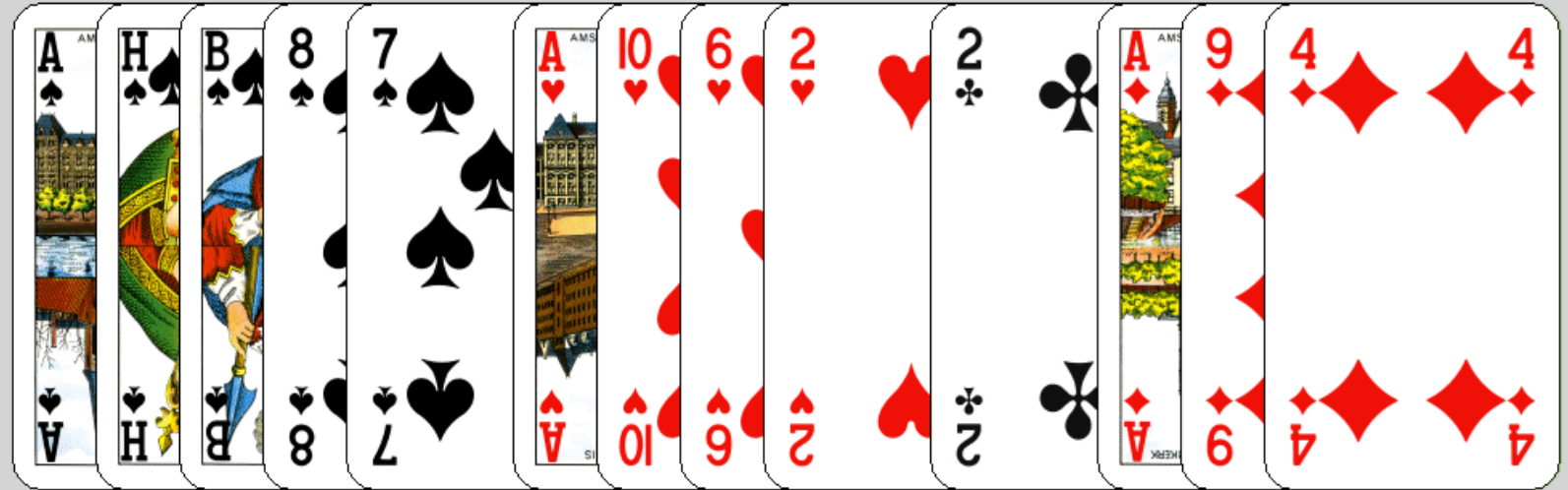

Analyse

| | |
|------------|----------|
| Punten? | 16 |
| Verdeling? | 5♠-4-3-1 |
| Bod? | 3♠ |

Je belooft

- 15-19 pnt
- goede 5+ krt ♠

Verdediging tegen een preëemptieve opening (2)

| | | | |
|----------|----------|----------|----------|
| W | N | O | Z |
| | | 3♥ | dbl |

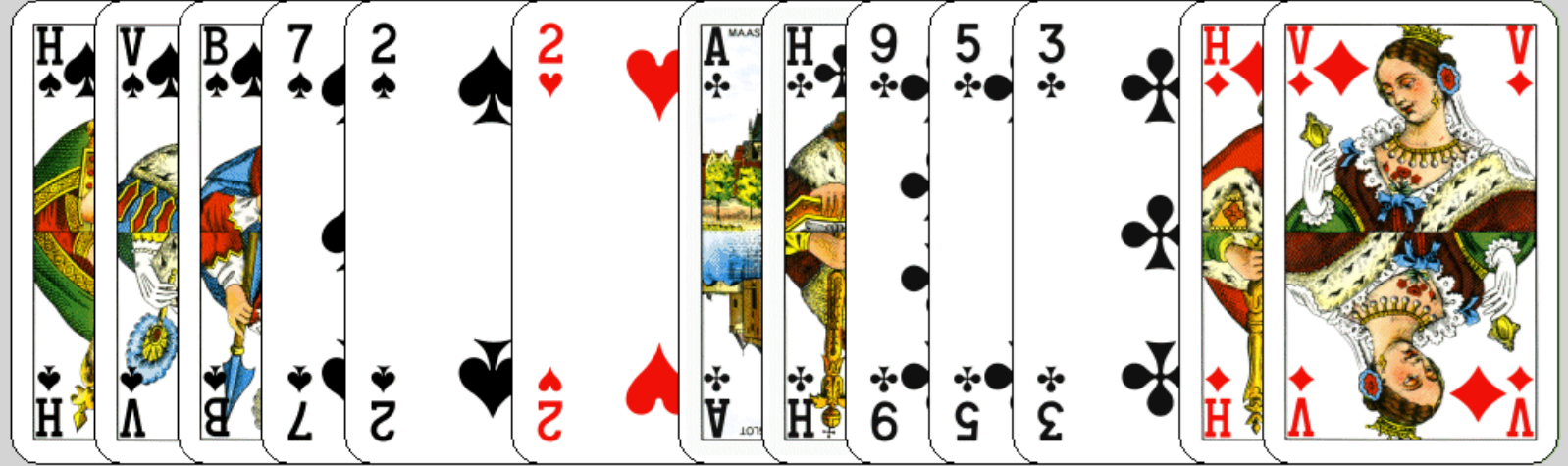

Analyse

| | |
|------------|-----------|
| Punten? | 18 |
| Verdeling? | 5♠-5♣-2-1 |
| Bod? | doublet |

Na bod partner

- Bied 4♠ als partner ruiten biedt

Verdediging tegen een preëemptieve opening (3)

| W | N | O | Z |
|---|---|----|-----|
| | | 3♥ | pas |

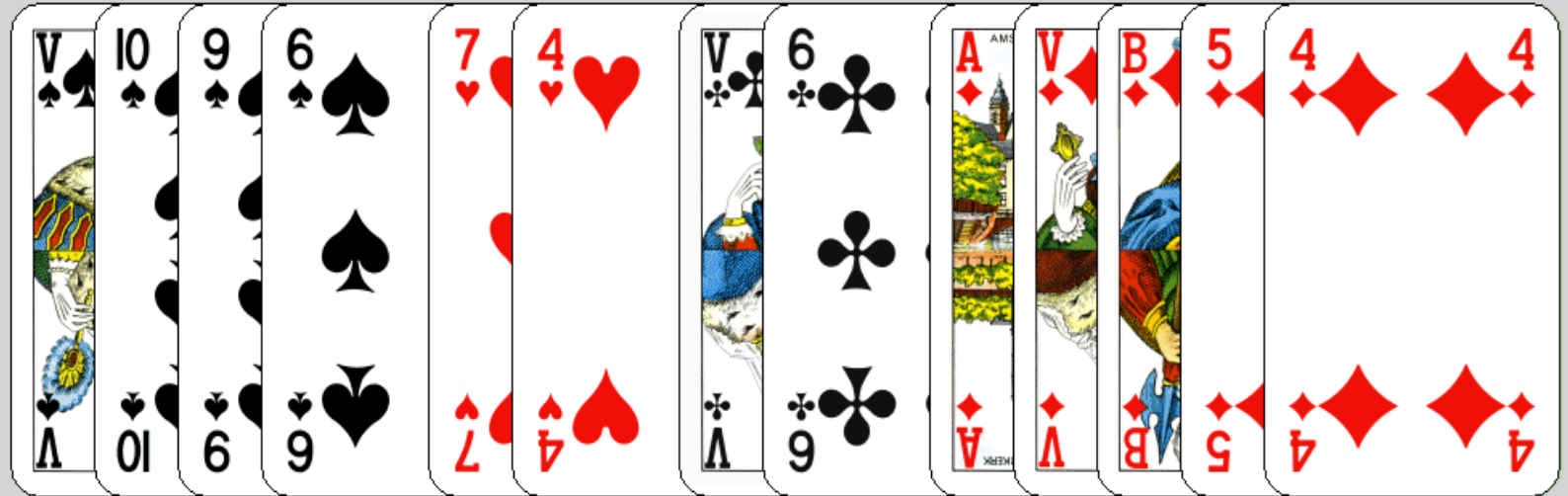

Analyse

| | |
|------------|----------|
| Punten? | 11 |
| Verdeling? | 5♦-4-3-2 |
| Bod? | pas |

Niets te melden

- te weinig speelslagen om op 4 niveau ruiten te bieden

Verdediging tegen een preëemptieve opening (4)

| W | N | O | Z |
|---|---|----|-----|
| | | 3♥ | 3SA |

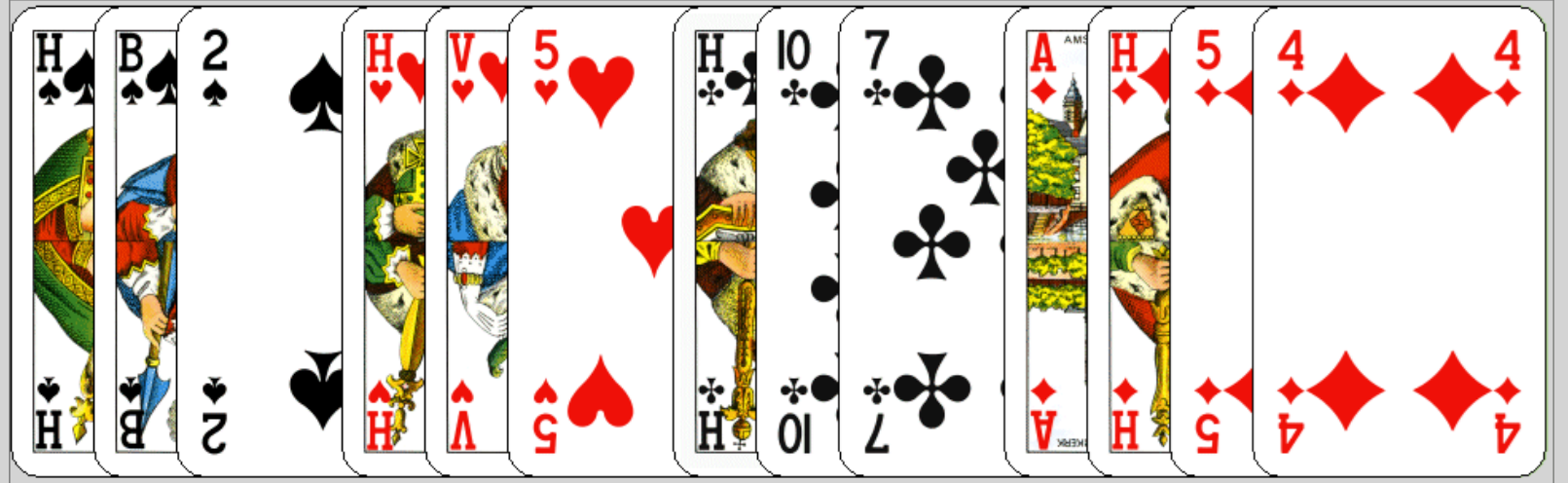

Analyse

| | |
|------------|---------|
| Punten? | 19 |
| Verdeling? | 4-3-3-3 |
| Bod? | 3SA |

Je belooft

- 18+ pnt
- evenwichtig
- goede stop in ♥

Soorten volgbiedingen

| | | |
|---|--|--|
| Zonder sprong op 1 niveau | Zonder sprong op 2 niveau | volgbod 1SA |
| <ul style="list-style-type: none">▪ 8-16 pnt▪ 5+ krt | <ul style="list-style-type: none">▪ 10-16 pnt▪ 5+ krt | <ul style="list-style-type: none">▪ 15-17 pnt▪ stop▪ evenwichtig |

- Nieuw

| | | |
|--|--|---|
| Met sprong | Informatie Doublet | Met dubbele sprong |
| <ul style="list-style-type: none">▪ 6-10 pnt▪ 6 krt | <ul style="list-style-type: none">▪ 12-16 pnt➤ max 2 krt openingskleur▪ 17+ pnt➤ iedere verdeling | <ul style="list-style-type: none">▪ 6-10 pnt▪ 7+ krt |

Volgbod met dubbele sprong

| | | | |
|----------|----------|----------|----------|
| W | N | O | Z |
| | | 1♣ | 3♥ |

Stop

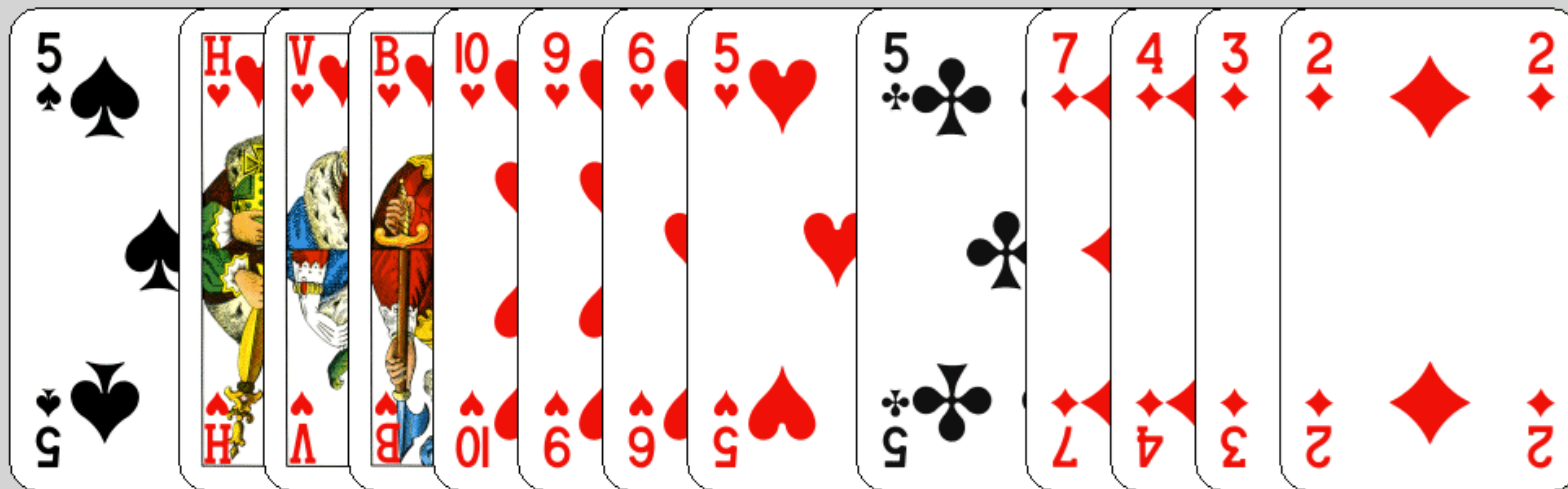

Analyse

| | |
|--------------------------|----|
| Punten? | 6 |
| Speelslagen met ♥ troef? | 6 |
| Bod? | 3♥ |

Volgbod met dubbele sprong

- 6-10 pnt
- goede 7-krt

Bieden en spelen

1. Spel bieden
2. Spel afspelen
 - resultaat bepalen
3. Nabespreking

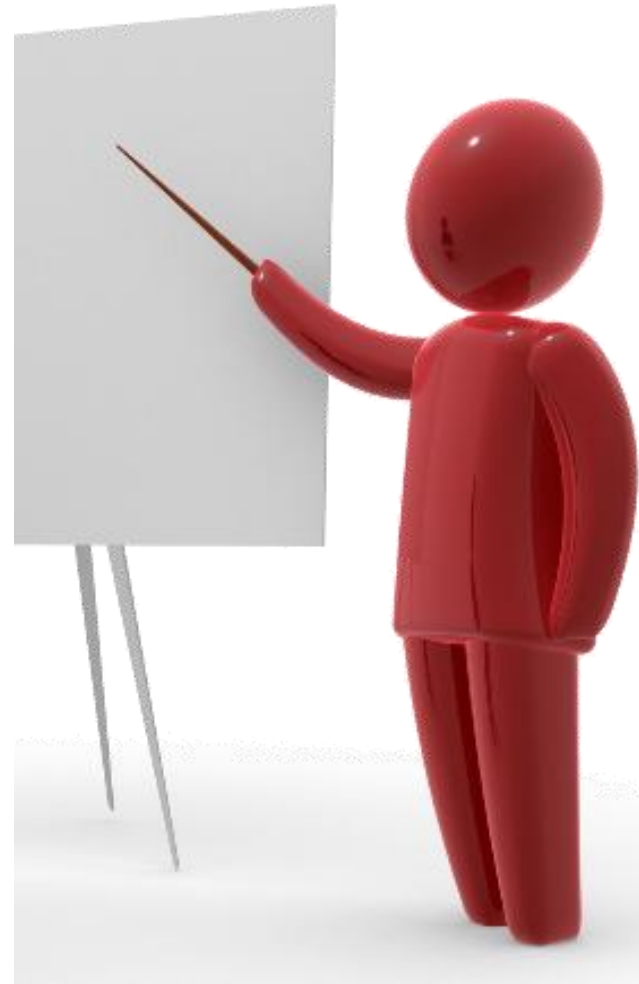

Spel 1

North: 10♠, 9♠, 6♠, A♥, V♥, 10♥, 7♥, 4♥, 3♥, 6♣, V♦, B♦, 7♦, 7♦

South: 7♠, 5♠, 5♠, A♥, 9♥, 5♥, 5♥, A♣, V♣, B♣, 9♣, 5♣, 2♣, 2♣, H♥, 9♦, 9♦, 9♦, H♥, 6♦, 6♦, 6♦

West: B♠, 4♠, 3♠, 2♠, 2♠, 2♥, 2♥, 2♥, 10♣, 7♣, 3♣, 3♣, 10♦, 6♦, 5♦, 3♦, 2♦, 2♦, 10♦, 9♦, 5♦, 3♦, 2♦, 2♦

East: A♠, H♠, V♠, 8♠, B♥, 8♥, 6♥, 6♥, H♣, 8♣, 4♣, 4♣, A♦, 8♦, 4♦, 4♦, 4♦

North 4♥

| W | N | O | Z |
|-----|-----|-----|----|
| | 2♥ | 3♣ | 4♥ |
| pas | pas | pas | |

- Uitkomst: ♠7
- Spelen

| speelplan troef | ♠ | ♥ | ♣ | ♦ |
|-------------------------|---|---|---|---|
| verliezers | 0 | 1 | 1 | 1 |
| mogelijkheden wegwerken | | | | |
| snijden | | | 1 | 1 |
| aftroeven korte kant | | | | |
| afgooien hoge kaart | | | | |

- Resultaat: 4♥ +1

Spel 2

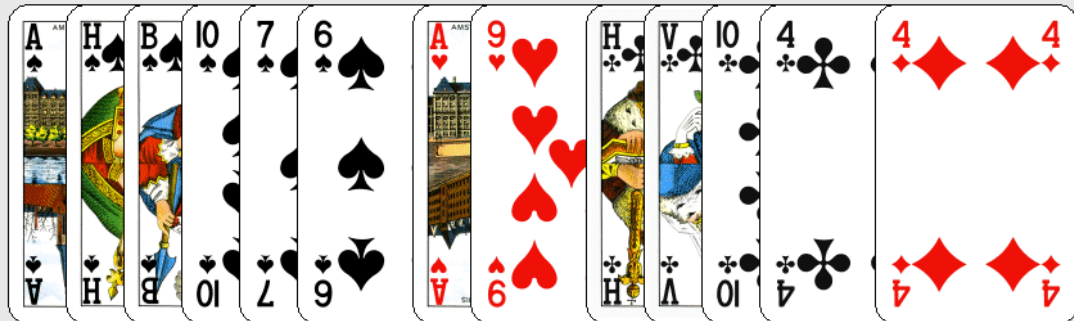
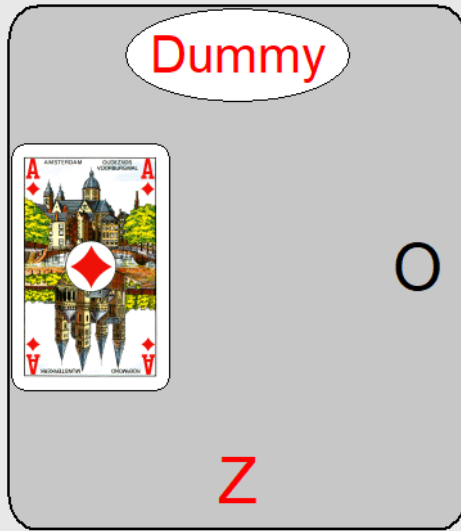
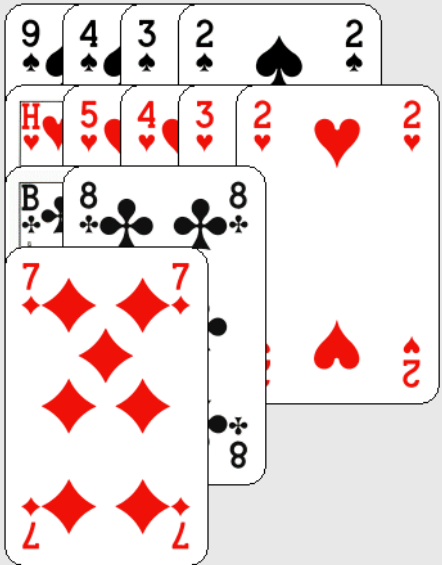
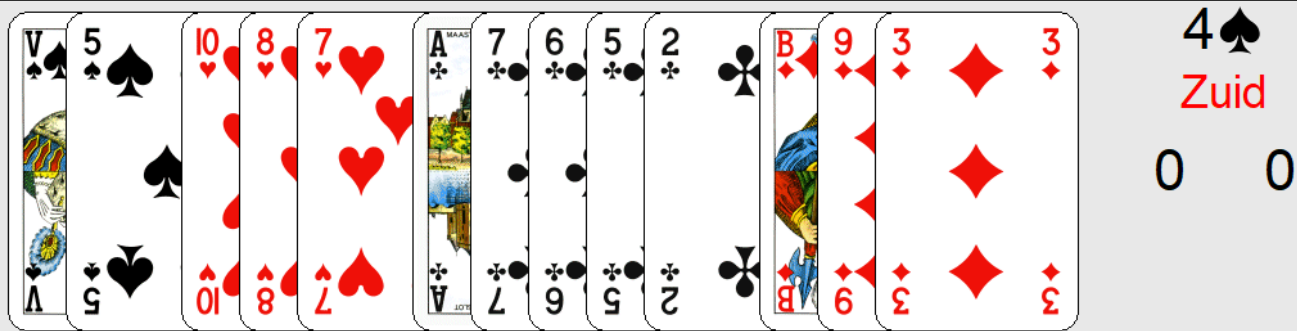

| W | N | O | Z |
|-----|-----|-----|----|
| | | 3♦ | 4♠ |
| pas | pas | pas | |

Spelen

| speelplan troef | ♠ | ♥ | ♣ | ♦ |
|-------------------------|---|---|---|---|
| verliezers | 0 | 1 | 0 | 1 |
| mogelijkheden wegwerken | | | | |
| snijden | | | | |
| aftroeven korte kant | | | | |
| afgooien hoge kaart | | 1 | | |

Resultaat: 4♠ +2

Spel 3

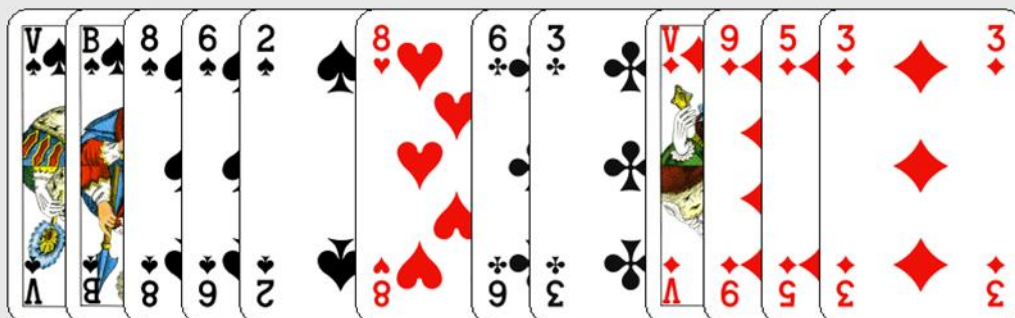
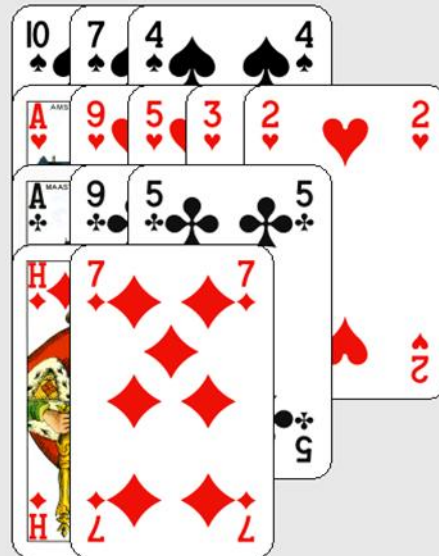
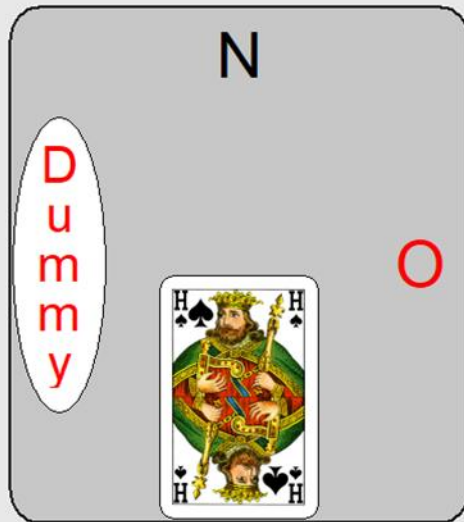
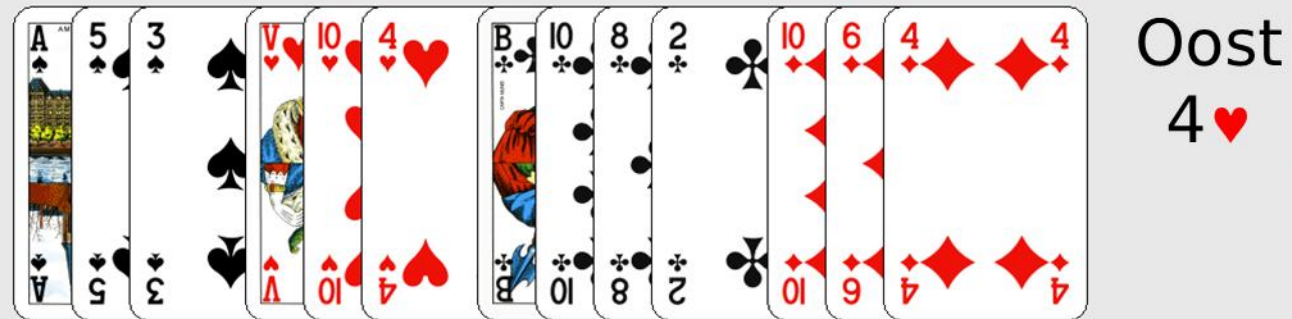

| W | N | O | Z |
|-----|-----|----|-----|
| | | | 2♠ |
| dbl | pas | 4♥ | pas |

Spelen

| speelplan troef | ♠ | ♥ | ♣ | ♦ |
|-------------------------|---|---|---|---|
| verliezers | 3 | 1 | 0 | 0 |
| mogelijkheden wegwerken | | | | |
| snijden | | | | |
| aftroeven korte kant | 2 | | | |
| afgooien hoge kaart | | | | |

Resultaat: 4♥ +1



Start met bridge 2

Jacques Barendregt en Koos Vrieze

Hoofdstuk
10

- Huiswerk
 - theorieboek: hoofdstuk 10
 - werkboek: hoofdstuk 10
 - oefenen in BIC: de Toekomstclub